

# Aer

Salvatore Indriolo, 2013-16

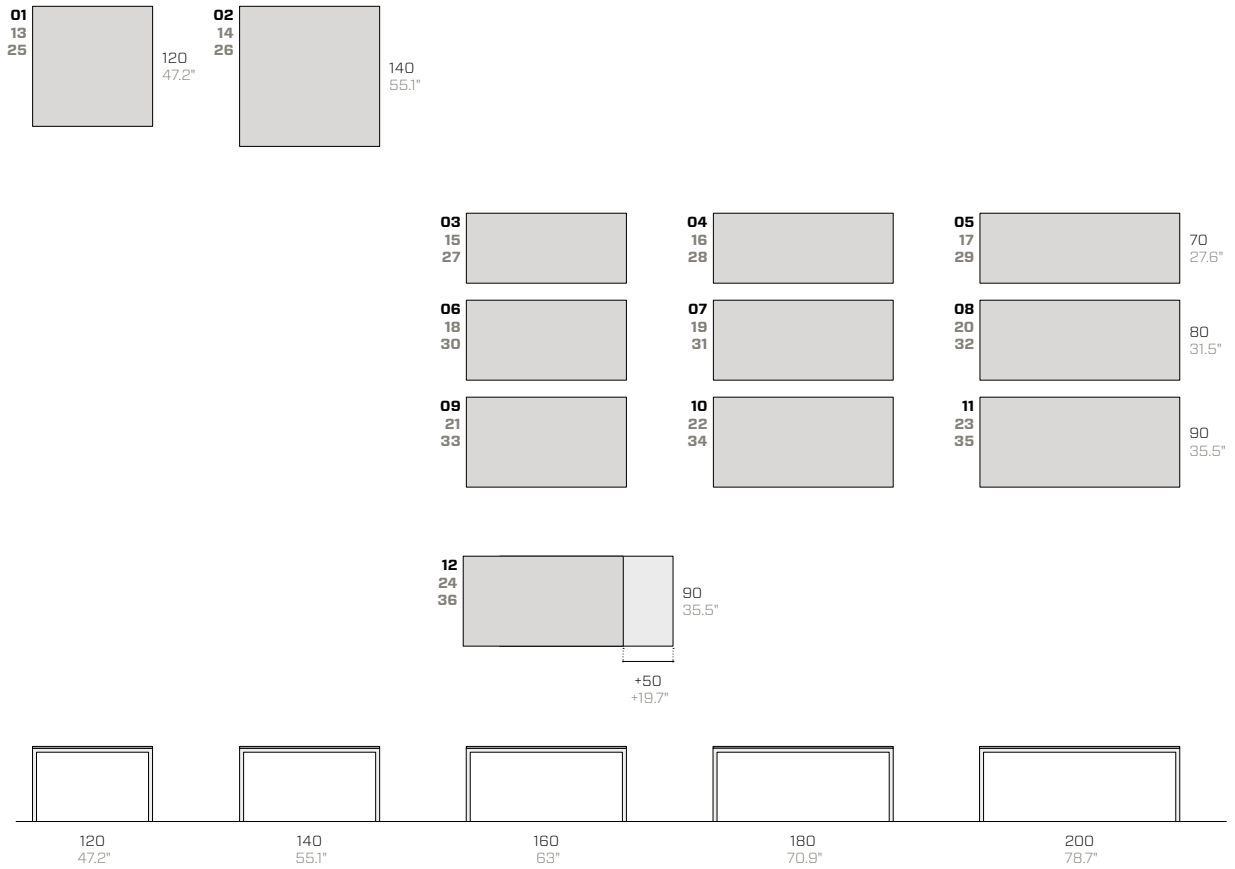

Table / Tavolo / Tisch



Top thickness / Spessore dei piani / Plattenstärke

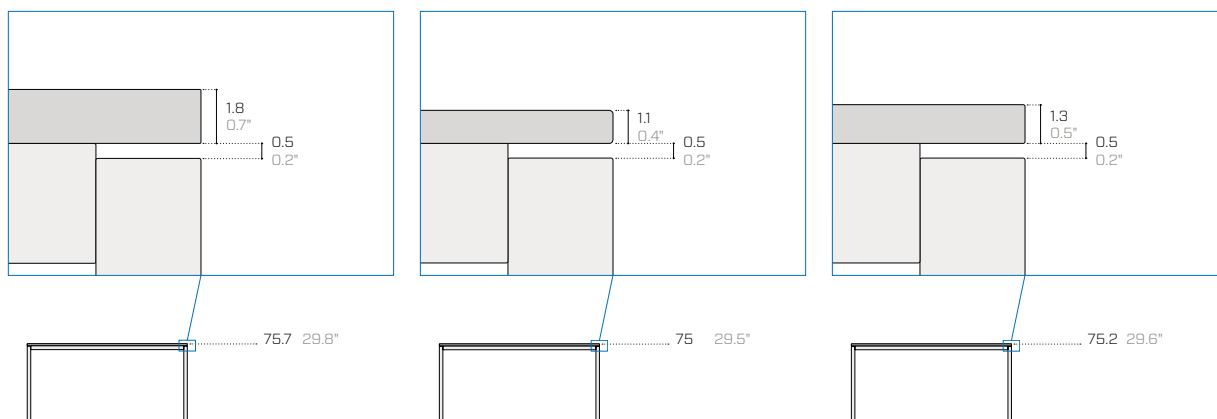

With melamine coated top  
Con piano in nobilitato  
Mit Melaminbeschichtete Tischplatte

With wooden top  
Con piano in legno  
Mit Holztischplatte

With metal top  
Con piano in metallo  
Mit Arbeitsplatte aus Metall

| Product / Prodotto / Produkt |        |                     |         | Packaging / Imballo / Verpackung |         |            |  |
|------------------------------|--------|---------------------|---------|----------------------------------|---------|------------|--|
| No.                          | Code   | Dimensions (w-d-h)  | Weight  | Dimensions (w-d-h)               | Weight  | Vol pkg    |  |
| N.                           | Codice | Dimensioni (l-p-h)  | Peso    | Dimensioni (l-p-h)               | Peso    | Vol. collo |  |
| Nr.                          | Code   | Abmessungen (b-t-h) | Gewicht | Abmessungen (b-t-h)              | Gewicht | Vol. Kollo |  |
|                              |        | cm                  | kg      | cm                               | kg      | mc         |  |

**With melamine coated top / Con piano in nobilitato / Mit melaminbeschichtete Tischplatte**

|    |        |                 |    |           |    |      |
|----|--------|-----------------|----|-----------|----|------|
| 01 | F483   | 120 120 75.7    | 37 | 125 125 8 | 53 | 0.13 |
| 02 | F484   | 140 140 75.7    | 48 | 145 145 8 | 64 | 0.17 |
| 03 | F460   | 160 70 75.7     | 32 | 165 75 8  | 48 | 0.10 |
| 04 | F461   | 180 70 75.7     | 34 | 185 75 8  | 50 | 0.11 |
| 05 | F462   | 200 70 75.7     | 36 | 205 75 8  | 52 | 0.12 |
| 06 | F463   | 160 80 75.7     | 35 | 165 85 8  | 51 | 0.11 |
| 07 | F464   | 180 80 75.7     | 37 | 185 85 8  | 53 | 0.13 |
| 08 | F465   | 200 80 75.7     | 40 | 205 85 8  | 56 | 0.14 |
| 09 | F466   | 160 90 75.7     | 38 | 165 95 8  | 54 | 0.13 |
| 10 | F467   | 180 90 75.7     | 41 | 185 95 8  | 57 | 0.14 |
| 11 | F468   | 200 90 75.7     | 44 | 205 95 8  | 60 | 0.16 |
| 12 | F466AL | 160/210 90 75.2 | 50 | 165 95 8  | 66 | 0.13 |

**With metal top / Con piano in metallo / Mit Arbeitsplatte aus Metall**

|    |        |                 |    |           |    |      |
|----|--------|-----------------|----|-----------|----|------|
| 13 | F487   | 120 120 75.2    | 39 | 125 125 8 | 55 | 0.13 |
| 14 | F488   | 140 140 75.2    | 55 | 145 145 8 | 71 | 0.17 |
| 15 | F510   | 160 70 75.2     | 36 | 165 75 8  | 52 | 0.10 |
| 16 | F511   | 180 70 75.2     | 38 | 185 75 8  | 54 | 0.11 |
| 17 | F512   | 200 70 75.2     | 41 | 205 75 8  | 57 | 0.12 |
| 18 | F513   | 160 80 75.2     | 39 | 165 85 8  | 55 | 0.11 |
| 19 | F514   | 180 80 75.2     | 42 | 185 85 8  | 58 | 0.13 |
| 20 | F515   | 200 80 75.2     | 45 | 205 85 8  | 61 | 0.14 |
| 21 | F516   | 160 90 75.2     | 42 | 165 95 8  | 58 | 0.13 |
| 22 | F517   | 180 90 75.2     | 46 | 185 95 8  | 62 | 0.14 |
| 23 | F518   | 200 90 75.2     | 49 | 205 95 8  | 65 | 0.16 |
| 24 | F516AL | 160/210 90 75.2 | 54 | 165 95 8  | 70 | 0.13 |

**With wooden top / Con piano in legno / Mit Holztischplatte**

|    |        |                 |    |           |    |      |
|----|--------|-----------------|----|-----------|----|------|
| 25 | F485   | 120 120 75.0    | 33 | 125 125 8 | 49 | 0.13 |
| 26 | F486   | 140 140 75.0    | 47 | 145 145 8 | 63 | 0.17 |
| 27 | F470   | 160 70 75.0     | 30 | 165 75 8  | 46 | 0.10 |
| 28 | F471   | 180 70 75.0     | 33 | 185 75 8  | 49 | 0.11 |
| 29 | F472   | 200 70 75.0     | 35 | 205 75 8  | 51 | 0.12 |
| 30 | F473   | 160 80 75.0     | 33 | 165 85 8  | 49 | 0.11 |
| 31 | F474   | 180 80 75.0     | 36 | 185 85 8  | 52 | 0.13 |
| 32 | F475   | 200 80 75.0     | 39 | 205 85 8  | 55 | 0.14 |
| 33 | F476   | 160 90 75.0     | 36 | 165 95 8  | 52 | 0.13 |
| 34 | F477   | 180 90 75.0     | 39 | 185 95 8  | 55 | 0.14 |
| 35 | F478   | 200 90 75.0     | 42 | 205 95 8  | 58 | 0.16 |
| 36 | F476AL | 160/210 90 75.2 | 48 | 165 95 8  | 64 | 0.13 |

Models 12, 24, 36 available from October 2019 / Modelli 12, 24, 36 disponibili da Ottobre 2019 / Modelle n 12, 24, 36 verfügbar ab October 2019

The packaging details are for products that require assembly / I dati di imballo si riferiscono al prodotto smontato / Die Verpackungsdaten beziehen sich auf das unmontierte Produkt

Coffee table / Tavolino / Tischchen

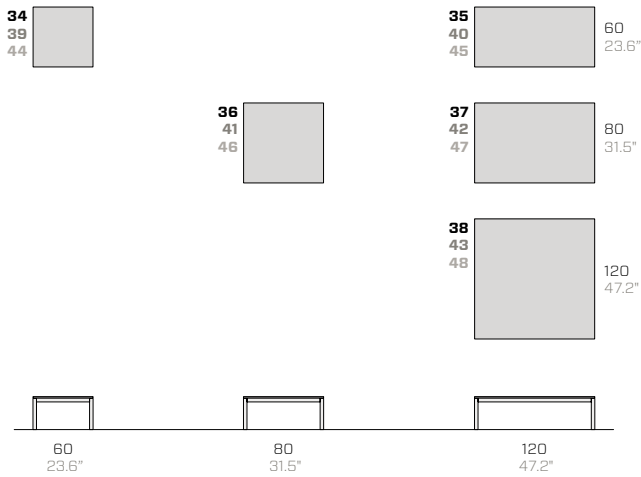

Bench / Panca / Bank

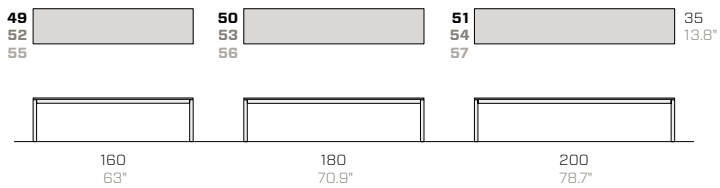

Top thickness / Spessore dei piani / Plattenstärke

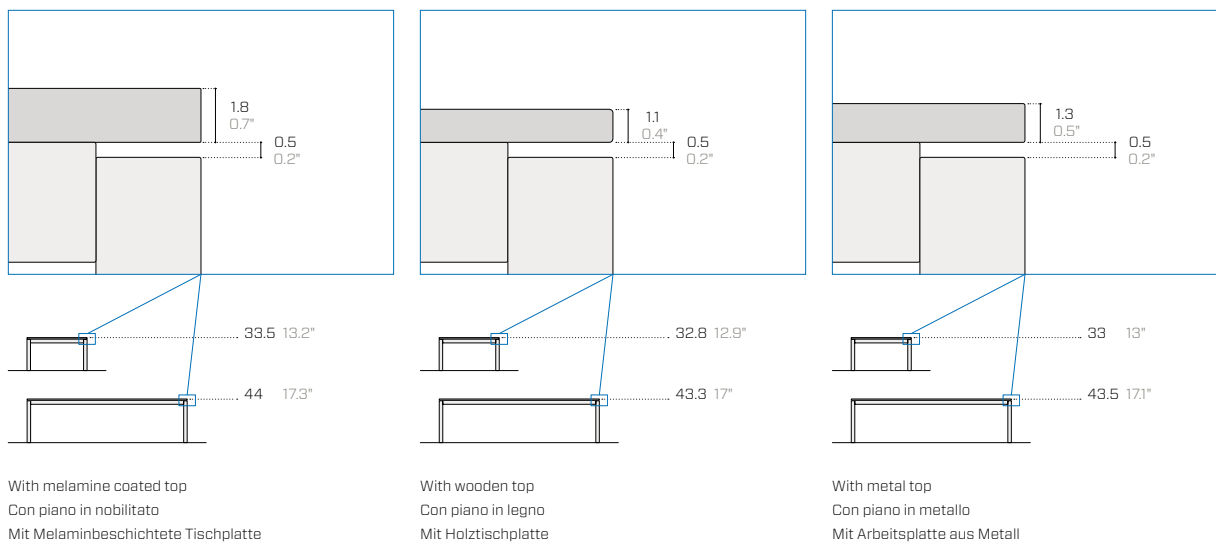

| Product / Prodotto / Produkt  |        |                     |     | Packaging / Imballo / Verpackung |         |                     |     |      |         |            |
|---|--------|---------------------|-----|----------------------------------|---------|---------------------|-----|------|---------|------------|
| No.   | Code   | Dimensions (w-d-h)  |     |                                  | Weight  | Dimensions (w-d-h)  |     |      | Weight  | Vol pkg    |
| N.  | Codice | Dimensioni (l-p-h)  |     |                                  | Peso    | Dimensioni (l-p-h)  |     |      | Peso    | Vol. collo |
| Nr.   | Code   | Abmessungen (b-t-h) |     |                                  | Gewicht | Abmessungen (b-t-h) |     |      | Gewicht | Vol. Kollo |
|   |        | cm                  |     |                                  | kg      | cm                  |     |      | kg      | mc         |
| <b>Coffee table with melamine coated top / Tavolino con piano in nobilitato / Tischchen mit melaminbeschichtete Tischplatte</b> |        |                     |     |                                  |         |                     |     |      |         |            |
| 34  | F541   | 60                  | 60  | 33.5                             | 15      | 65                  | 65  | 43.5 | 22      | 0.18       |
| 35  | F542   | 120                 | 60  | 33.5                             | 20      | 125                 | 65  | 43.5 | 27      | 0.35       |
| 36  | F543   | 80                  | 80  | 33.5                             | 19      | 85                  | 85  | 43.5 | 26      | 0.31       |
| 37  | F544   | 120                 | 80  | 33.5                             | 23      | 125                 | 85  | 43.5 | 30      | 0.46       |
| 38  | F545   | 120                 | 120 | 33.5                             | 30      | 125                 | 125 | 43.5 | 37      | 0.68       |
| <b>Coffee table with metal top / Tavolino con piano in metallo / Tischchen mit Arbeitsplatte aus Metall</b>                     |        |                     |     |                                  |         |                     |     |      |         |            |
| 39  | F561   | 60                  | 60  | 33                               | 18      | 65                  | 65  | 43   | 25      | 0.18       |
| 40  | F562   | 120                 | 60  | 33                               | 26      | 125                 | 65  | 43   | 33      | 0.35       |
| 41  | F563   | 80                  | 80  | 33                               | 25      | 85                  | 85  | 43   | 32      | 0.31       |
| 42  | F564   | 120                 | 80  | 33                               | 32      | 125                 | 85  | 43   | 39      | 0.46       |
| 43  | F565   | 120                 | 120 | 33                               | 43      | 125                 | 125 | 43   | 50      | 0.67       |
| <b>Coffee table with wooden top / Tavolino con piano in legno / Tischchen mit Holztischplatte</b>                               |        |                     |     |                                  |         |                     |     |      |         |            |
| 44  | F551   | 60                  | 60  | 32.8                             | 15      | 65                  | 65  | 42.8 | 22      | 0.18       |
| 45  | F552   | 120                 | 60  | 32.8                             | 18      | 125                 | 65  | 42.8 | 25      | 0.35       |
| 46  | F553   | 80                  | 80  | 32.8                             | 19      | 85                  | 85  | 42.8 | 26      | 0.31       |
| 47  | F554   | 120                 | 80  | 32.8                             | 21      | 125                 | 85  | 42.8 | 28      | 0.45       |
| 48  | F555   | 120                 | 120 | 32.8                             | 28      | 125                 | 125 | 42.8 | 35      | 0.67       |
| <b>Bench with melamine coated top / Panca con piano in nobilitato / Bank mit melaminbeschichtete Tischplatte</b>                |        |                     |     |                                  |         |                     |     |      |         |            |
| 49  | F520   | 160                 | 35  | 44                               | 15      | 165                 | 40  | 54   | 22      | 0.36       |
| 50  | F521   | 180                 | 35  | 44                               | 16      | 185                 | 40  | 54   | 23      | 0.40       |
| 51  | F522   | 200                 | 35  | 44                               | 17      | 205                 | 40  | 54   | 24      | 0.44       |
| <b>Bench with metal top / Panca con piano in metallo / Bank mit Arbeitsplatte aus Metall</b>                                    |        |                     |     |                                  |         |                     |     |      |         |            |
| 52  | F526   | 160                 | 35  | 43.5                             | 22      | 165                 | 40  | 53.5 | 29      | 0.35       |
| 53  | F527   | 180                 | 35  | 43.5                             | 23      | 185                 | 40  | 53.5 | 30      | 0.40       |
| 54  | F528   | 200                 | 35  | 43.5                             | 24      | 205                 | 40  | 53.5 | 31      | 0.44       |
| <b>Bench with wooden top / Panca con piano in legno / Bank mit Holztischplatte</b>  |        |                     |     |                                  |         |                     |     |      |         |            |
| 55  | F523   | 160                 | 35  | 43.3                             | 15      | 165                 | 40  | 53.3 | 22      | 0.35       |
| 56  | F524   | 180                 | 35  | 43.3                             | 16      | 185                 | 40  | 53.3 | 23      | 0.39       |
| 57  | F525   | 200                 | 35  | 43.3                             | 17      | 205                 | 40  | 53.3 | 24      | 0.44       |

The packaging details are for assembled products / I dati di imballo si riferiscono al prodotto montato / Die Verpackungsdaten beziehen sich auf das montierte Produkt



## Metal essentials

UM = Ultra matt / Ultra opaco / Ultra matt

MT = Matt / Opaco / Matt

EM = Embossed / Goffrato / Gaufriert

**01.18  
Black (RAL 9005)**

Nero / Schwarz

-

MT

EM

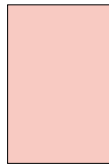
**08.18  
Rose quartz**

Rosa quarzo / Rosenquarz

-

MT

**15.19  
Forest green (RAL 6007)**

Verde bosco / Waldgrün

-

EM

**02.18  
Anthracite (RAL 7021)**

Antracite / Anthrazit

-

MT

EM

**09.18  
Ruby red (RAL 3003)**

Rosso rubino / Rubinrot

-

MT

EM

**16.19  
Turquoise blue (RAL 5018)**

Blu turchese / Türkisblau

-

EM

**03.18  
Fantin grey**

Grigio Fantin / Fantin-Grau

-

EM

**10.18  
Traffic red (RAL 3020)**

Rosso traffico / Verkehrsrot

-

MT

EM

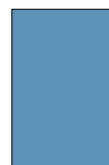
**17.18  
Pastel blue (RAL 5024)**

Blu pastello / Pastellblau

-

MT

EM

**04.18  
Light grey (RAL 7035)**

Grigio luce / Lichtgrau

-

MT

EM

**11.18  
Pure orange (RAL 2004)**

Arancio puro / Reinorange

-

MT

EM

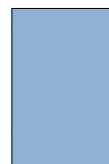
**18.18  
Serenity**

Serenity / Serenity

-

MT

**05.18  
Cloud grey**

Grigio nuvola / Wolkengrau

-

EM

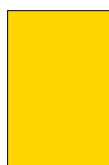
**12.19  
Zinc yellow (RAL 1018)**

Giallo zinco / Zinco gelb

-

EM

**19.18  
Gentian blue (RAL 5010)**

Blu genziana / Enzianblau

-

MT

EM

**06.18  
White (RAL 9016)**

Bianco / Weiß

-

MT

EM

**13.19  
Mint green (RAL 6024)**

Verde menta / Minzgrün

-

EM

**20.19  
Steel blue (RAL 5011)**

Blu acciaio / Stahlblau

-

EM

**07.18  
Pearl white (RAL 1013)**

Bianco perla / Perlweiß

-

MT

EM

**14.18  
Sage green (RAL 6021)**

Verde salvia / Salbeigrün

-

MT

EM

**Metal design\***

UM = Ultra matt / Ultra opaco / Ultra matt

MT = Matt / Opaco / Matt

EM = Embossed / Goffrato / Gaufriert

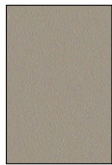
**Ultra-matt\*****31.18  
Cocoa**  
Cacao / Kakao  
-  
UM**32.18  
Dove grey**  
Tortora / Taubengrau  
-  
UM**33.18  
Hemp**  
Canapa / Hanf  
-  
UM**34.18  
Smoke**  
Fumo / Rauchen  
-  
UM**35.18  
Night**  
Notte / Nacht  
-  
UM**Metallic\*****41.18  
Gold**  
Oro / Gold  
-  
EM**42.19  
Rust**  
Ruggine / Rost  
-  
EM**43.18  
Bronze**  
Bronzo / Bronze  
-  
EM**44.18  
Iron**  
Ferro / Eisen  
-  
EM**45.18  
Verdigris**  
Verderame / Grünspan  
-  
EM**Earth\*****51.18  
Sand**  
Sabbia / Sand  
-  
EM**52.18  
Moss**  
Muschio / Moos  
-  
EM**53.18  
Basalt**  
Basalto / Basalt  
-  
EM**54.18  
Stone**  
Pietra / Stein  
-  
EM**55.18  
Amethyst**  
Ametista / Amethyst  
-  
EM**Instructions for use / Indicazioni d'uso / Anwendungshinweise**Finishes  
Finiture  
FinishesFor tops  
Per i top  
Für die AbdeckungenFor outdoor use  
Per esterni  
Für den AußenbereichUM = Ultra matt / Ultra opaco / Ultra matt  
MT = Matt / Opaco / Matt  
EM = Embossed / Goffrato / Gaufriert-  
-  
+-  
+  
+

**Wood  
Legno  
Holz**

**Melamine coated  
Nobilitato  
Melaminbeschichtet**



**W1.18  
Natural oak**  
Rovere naturale / Eiche hell



**M1.18  
Grey**  
Grigio / Grau



**W2.18  
Bleached oak**  
Rovere sbiancato / Eiche gebleicht



**M2.18  
White**  
Bianco / Weiß



**W3.18  
Dark oak**  
Rovere scuro / Eiche dun



**M3.18  
Ivory**  
Avorio / Elfenbeinfarben



**W4.18  
Canaletto walnut**  
Noce canaletto / Schwarznuss



**M4.18  
Natural oak**  
Rovere naturale / Eiche hell



**W5.18  
Fir wood**  
Abete / Fichte



**M5.18  
Dark oak**  
Rovere scuro / Eiche dun



### Technical information

**Metal** Non-toxic powder coating for interior use, with no heavy metals. Cured in an oven at 190°C, following degreasing and phosphating. Guaranteed minimum thickness of 50 microns. Minimum resistance to salt spray of 200 hours (in accordance with the ASTM B117 standard). Not suitable for direct contact with food as envisaged in Italian Ministerial Decree 21/03/73. Before the coating is added, it is possible to assess whether to give the products a special treatment to make them more resistant to wear and exposure to the elements. There is a surcharge for this treatment. Requests for other RAL finishes can be considered.

**Wood** Exquisite types of wood with veneers and under leaf edges, on a 55 kg/m<sup>3</sup> (3.43 lb/ft<sup>3</sup>) PVC and aluminium foam sandwich panel structure. All panels are given an acrylic coating and are certified "formaldehyde free". Panck products are an exception because they are made with solid fir slats that are sanded and given a natural coating. Requests for other finishes for the wood will be considered.

**Melamine coated** Faced top with a fibre-board structure and a coloured or wood-effect melamine finish. Requests for other melamine finishes will be considered.

### Informazioni tecniche

**Metallo** Verniciatura per interni a polveri atossiche prive di metalli pesanti, con passaggio in forno a 190 °C, previo trattamento di sgrassaggio e fosfatazione. Spessore minimo garantito 50 micron, resistenza minima in nebbia salina pari a 200 ore (norma ASTM B117). Non idonea al contatto diretto con gli alimenti come previsto dal decreto italiano D.M. 21/03/73. Prima della verniciatura, è possibile valutare l'applicazione di un trattamento al fine di rendere i prodotti più resistenti all'uso e all'esposizione agli agenti atmosferici. Per tale trattamento è prevista una maggiorazione di prezzo. Altre finiture RAL valutabili su richiesta.

**Legno** Pregiate essenze di legno impiallacciato con bordatura sottofoglia, su struttura in lastra sandwich di alluminio e PVC espanso 55 kg/m<sup>3</sup> (3.43 lb/ft<sup>3</sup>). Tutti i pannelli ricevono una verniciatura acrilica e sono certificati "privi di formaldeide". Il prodotto Panck è un'eccezione in quanto è composto da doghe in massello di abete levigato e verniciato al naturale. Altre finiture in legno sono valutabili su richiesta.

**Nobilitato** Piano in nobilitato con struttura in pannello di fibre di legno rivestito da finiture melaminiche colorate o effetto legno. Altre finiture melaminiche sono valutabili su richiesta.

### Technische Informationen

**Metall** Die Lackierung der gift- und schwermetallfreien Pulverlacke für Innenbereiche erfolgt im Lackierofen bei 190 °C nach vorheriger Entfettung und Phosphatierung. Die garantierte Mindeststärke der Lackschicht beträgt 50 Mikron bei einer Mindestprüfungsdauer von 200 Stunden im Salznebel (ASTM-Norm B117). Nicht für den direkten Kontakt mit Nahrungsmitteln geeignet, gemäß Ministerialdekret vom 21.03.1973 i.d.g.F. Vor der Lackierung kann die Anwendung einer Behandlung abgewägt werden, um die Produkte für den Gebrauch und gegen Witterungseinflüsse widerstandsfähiger zu machen. Für diese Behandlung ist ein Preisaufschlag vorgesehen. Auf Anfrage können andere RAL-Finishes in Betracht gezogen werden.

**Holz** Hochwertiges Holz furnier mit folienbedeckter Umrandung auf einer Struktur aus Alu-Sandwichplatte und PVC-Schaum 55 kg/m<sup>3</sup> (3.43 lb/ft<sup>3</sup>). Alle Paneele erhalten eine Acryl-Lackierung und sind formaldehydfrei zertifiziert. Eine Ausnahme bildet das Produkt Panck, denn es besteht aus Holzlatten aus massivem, poliertem und natürlich lackiertem Fichtenholz. Andere Holzfinishes können auf Anfrage abgewägt werden.

**Melaminbeschichtet** Melaminbeschichtete Tischplatte bestehend aus einer Holzfaserverplatte, die mit farbigen Melaminfinishes oder Holzeffektfinishes überzogen ist. Andere Melaminfinishes können auf Anfrage abgewägt werden.

The archetypal elements formed by the top and the legs are separated by a clear gap of a few millimetres to give a sense of lightness while still preserving the product's quintessential solidity.

**Load-bearing structure** made of 1.5 mm (0.06") thick welded 40 x 40 mm (1.57" x 1.57") square tubes. Extendable version in 160/210 x 90 cm (63.00"/82.68" x 35.50").

**Legs** made of 2 mm (0.08") thick welded 35 x 35 mm (1.38" x 1.38") square tubes. Each pair is welded to the load-bearing structure or attached to it with 2 screws. Concealed adjustable feet.

**Melamine coated top** with a fibreboard structure coated in coloured or wood-effect melamine. Top thickness: 18 mm (0.71").

**Veneered wooden top** on a 55 kg/m<sup>3</sup> (3.43 lb/ft<sup>3</sup>) PVC and aluminium foam sandwich panel structure. Formaldehyde-free 11 mm (0.43") thick top.

**Metal top** with fibreboard structure covered with 1 mm (0.04") thick sheet metal bent at the edges and welded on the corners. Top thickness: 13 mm (0.51").

The tables require assembly (assembled products are only provided on request). The coffee tables and benches are ready assembled.

I due elementi archetipi, il piano e le gambe, sono separati da pochi millimetri di aria per determinare una percezione di leggerezza, mantenendo la prerogativa della solidità.

**Struttura portante** saldata in tubolare quadrato 40 x 40 mm (1.57" x 1.57") di spessore 1.5 mm (0.06"). Versione allungabile nella misura 160/210 x 90 cm (63.00"/82.68" x 35.50").

**Gambe** saldate in tubolare quadrato 35 x 35 mm (1.38" x 1.38") di spessore 2 mm (0.08"). Ogni coppia si aggancia alla struttura portante tramite saldatura o 2 viti. Piedini invisibili regolabili.

**Piano in nobilitato** con struttura in pannello di fibre di legno rivestito da finiture melaminiche colorate o effetto legno. Spessore del piano 18 mm (0.71").

**Piano in legno** impiallacciato su struttura in lastra sandwich di alluminio e PVC espanso 55 kg/m<sup>3</sup> (3.43 lb/ft<sup>3</sup>). Piano di spessore 11 mm (0.43") privo di formaldeide.

**Piano in metallo** con struttura in pannello di fibre di legno rivestito da una lamiera di metallo di spessore 1 mm (0.04") piegata nei bordi e saldata negli spigoli. Spessore del piano 13 mm (0.51").

I tavoli sono forniti smontati (montati solo su richiesta). I tavolini e le panche sono forniti montati.

Die beiden archetypischen Elemente, die Tischplatte und die Beine, sind durch wenige Millimeter Luft voneinander getrennt und vermitteln so den Eindruck von Leichtigkeit, ohne ihre Stabilität zu verlieren.

**Verschweißtes Trägergestell** aus Metallvierkantrohr 40 x 40 mm (1.58" x 1.58") mit einer Stärke von 1.5 mm (0.06"). Ausziehbarer Ausführung in den Maßen 160/210 x 90 cm (63.00"/82.68" x 35.50").

**Verschweißte Beine** aus Metallvierkantrohr 35 x 35 mm (1.38" x 1.38") mit einer Stärke von 2 mm (0.08"). Jedes Beinpaar wird an das Trägergestell geschweißt oder mit 2 Schrauben befestigt. Unsichtbare einstellbare Füße.

**Melaminbeschichtete Tischplatte** bestehend aus einer Holzfaserverplatte, die mit farbigen Melaminfinishes oder Holzefektfinishes überzogen ist. Plattenstärke 18 mm (0.71").

**Tischplatte aus Holzfurnier** auf einer formaldehydfreien Struktur aus Alu-Sandwichplatte und PVC-Schaum 55 kg/m<sup>3</sup> (3.43 lb/ft<sup>3</sup>). Plattenstärke 11 mm (0.43"), formaldehydfrei.

**Metal-Tischplatte** bestehend aus einer Faserplatte, die mit einem 1 mm (0.04") starken Blech verkleidet ist, das an den Kanten gefalzt und an den Ecken geschweißt ist. Plattenstärke 13 mm (0.51").

Die Tische werden unmontiert geliefert (montiert nur auf Anfrage). Tischchen und Bänke werden montiert geliefert.

## Disclaimer / Esclusione di responsabilità / Haftungsausschluss

Fantin Srl reserves the right to change the dimensions and features of the products contained in this technical data sheet at any time and without prior notice. The finishes illustrated are purely indicative as the accuracy tolerances of printing processes should be taken into account.

Fantin Srl si riserva la facoltà di modificare in qualsiasi momento e senza preavviso le dimensioni e l'esecuzione dei prodotti contenuti nella presente scheda tecnica. Le finiture riportate hanno valore indicativo in quanto soggette alle tolleranze dei processi di stampa.

Fantin Srl behält sich das Recht vor, die angegebenen Maße und Ausführungen der Produkte, welche dieses Produktblatt enthält, jederzeit ohne Vorankündigung zu ändern. Aufgrund drucktechnischer Abweichungen dienen die dargestellten Ausführungen nur der Illustration.

## Fantin Srl

via San Vito, 43  
33080 - Bannia  
di Fiume Veneto (PN)  
Italia

t +39 0434 959 133  
f +39 0434 560 037  
fantin@fantin.com  
www.fantin.com



UNI EN ISO 9001