

# Binaria

Salvatore Indriolo, 2013

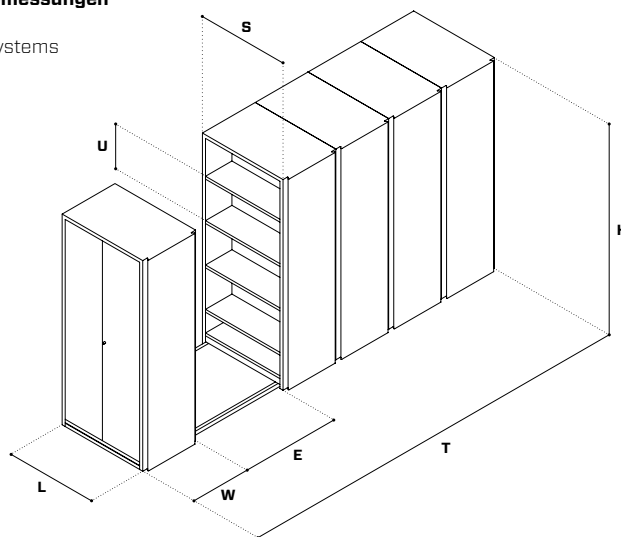

**Measurement diagram / Schema delle misure / Schema der Abmessungen****T** System translation / Traslazione impianto / Verschiebung des Systems**H** System height / Altezza impianto / Höhe des Systems**L** Passage length / Lunghezza corridoio / Länge des Korridors**E** Passage width / Larghezza corridoio / Breite des Korridors**W** Unit depth / Profondità modulo / Tiefe des Moduls**S** Span width / Larghezza campata / Fachbreite**U** Shelf interval / Passo ripiani / Fachabstand**Dimensions / Dimensioni / Abmessungen****W**

Static modules / Moduli fissi / Feste Module

30 cm

11.8"

Sliding modules / Moduli mobili / Bewegliche Module

60 cm

23.6"

**H**

214 / 254 cm

84.3" / 100"

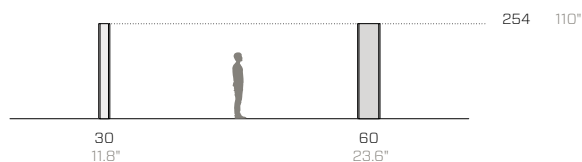
**L**

80 / 100 / 120 cm

31.5" / 39.4" / 47.2"

**Important notes / Note importanti / Wichtige Anmerkungen**

There are endless possibilities for internal configurations. For the sake of brevity, only the standard compositions shown on the left have been included. Sheet metal shelves with adjustable heights and 5 cm (1.97") intervals. The prices are for systems with metal covers. Platform and sliding rail system are included in the listed price. Shipping and installation excluded.

Gli allestimenti interni sono infiniti. Per necessità di sintesi, sono state considerate alcune composizioni standard. Ripiani in metallo regolabili in altezza con passo 5 cm (1.97"). I prezzi sono riferiti a impianti con cover in metallo. Pedana e sistema di scorrimento su rotaia sono compresi nel prezzo. Trasporto e montaggio esclusi.

Die Standard-Inneneinrichtungen sind unendlich viele. Aus Platzgründen wurden die Standard-Kompositionen berücksichtigt, die hier links grafisch dargestellt sind. Regalböden aus Blech in der Höhe verstellbar mit Abstand 5 cm (1.97"). Die angegebenen Preise beziehen sich auf Systeme mit Abdeckungen aus Metall. Trittbfläche und Schienensystem sind im angegebenen Preis enthalten. Transport und Montage ausgeschlossen.

**Modules L80 cm with central backboard / Moduli L80 cm con schiena centrale / Module L80 cm mit zentraler Rückwand**

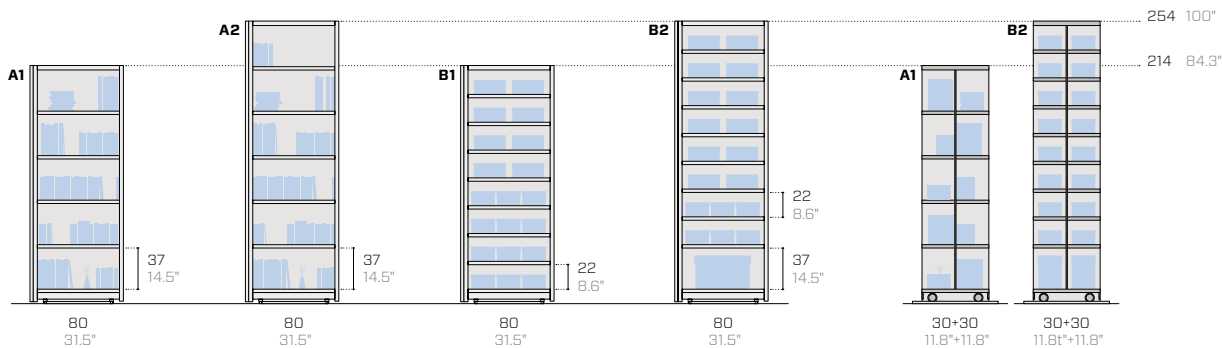

**Modules L80 cm with side backboard / Moduli L80 cm con schiena laterale / Module L80 cm mit Seitenwand**

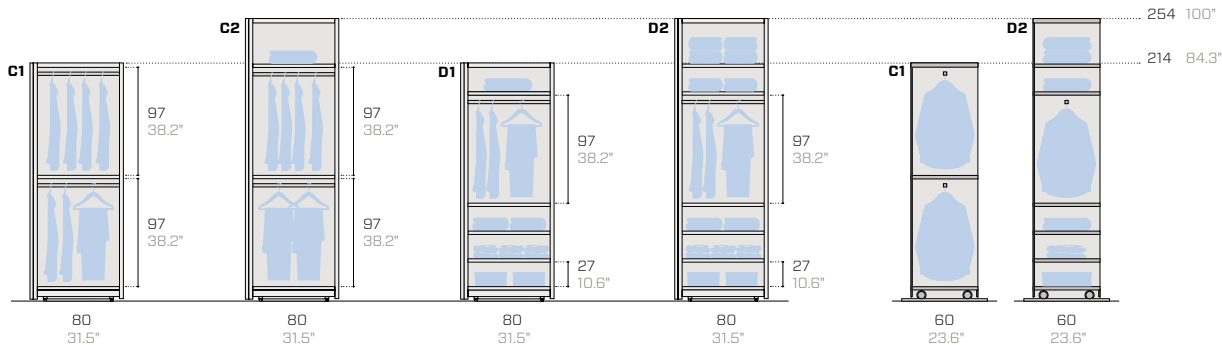

**Examples of composition L80 cm / Esempi di composizione L80 cm / Kompositionsbeispiele L80 cm**

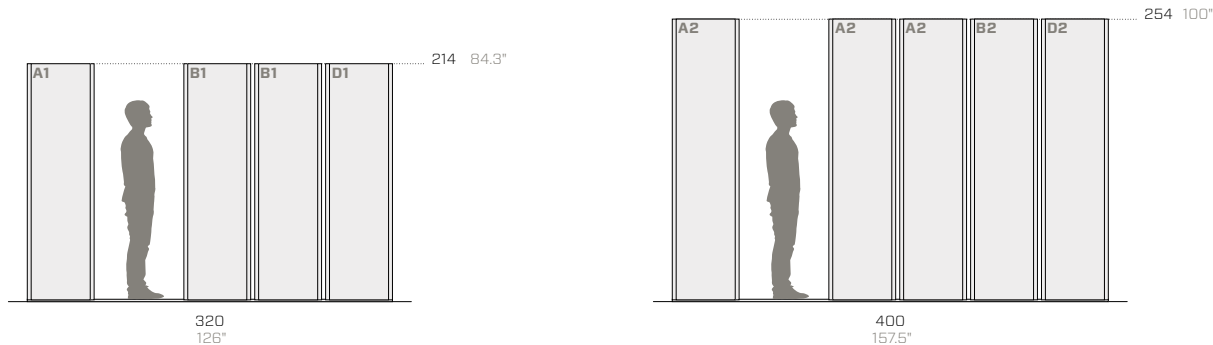

Modules L100 cm with central backboard / Moduli L100 cm con schiena centrale / Module L100 cm mit zentraler Rückwand

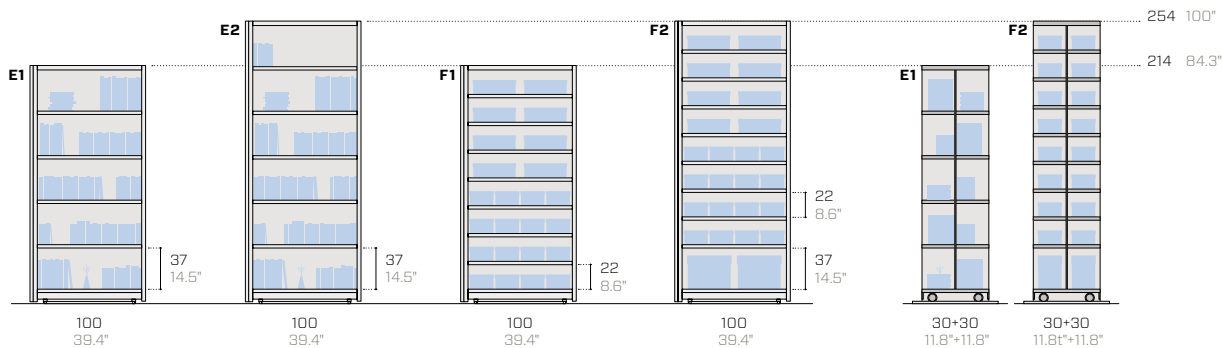

Modules L100 cm with side backboard / Moduli L100 cm con schiena laterale / Module L100 cm mit Seitenwand

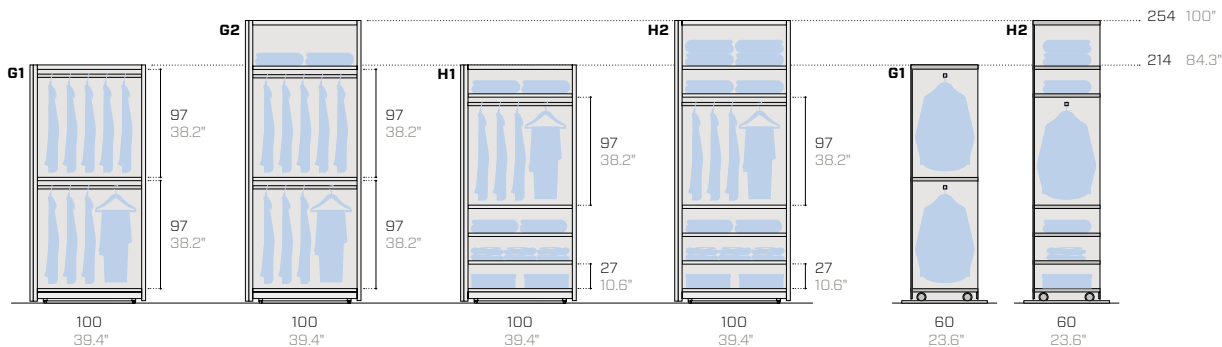

Examples of composition L100 cm / Esempi di composizione L100 cm / Kompositionsbeispiele L100 cm

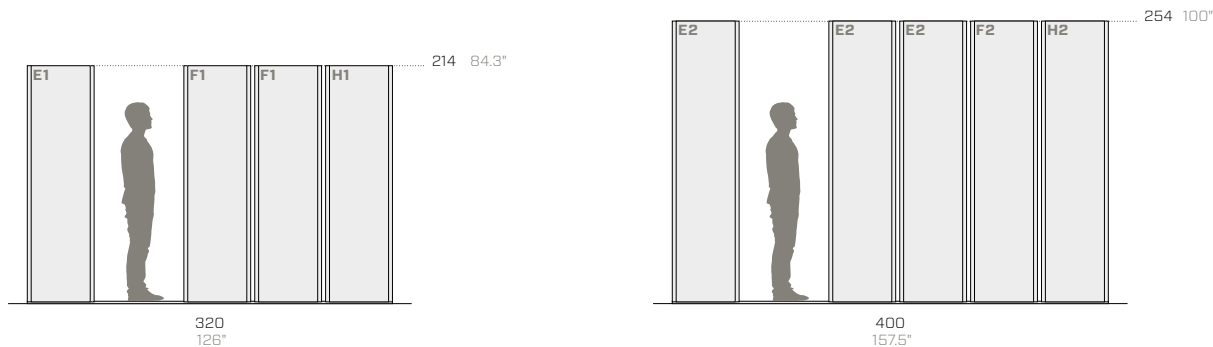

**Modules L120 cm with central backboard / Moduli L120 cm con schiena centrale / Module L120 cm mit zentraler Rückwand**

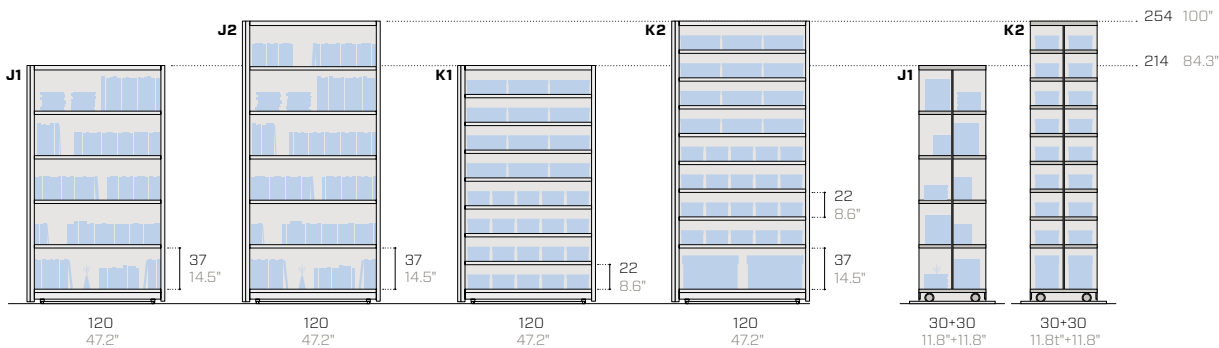

**Modules L120 cm with side backboard / Moduli L120 cm con schiena laterale / Module L120 cm mit Seitenwand**

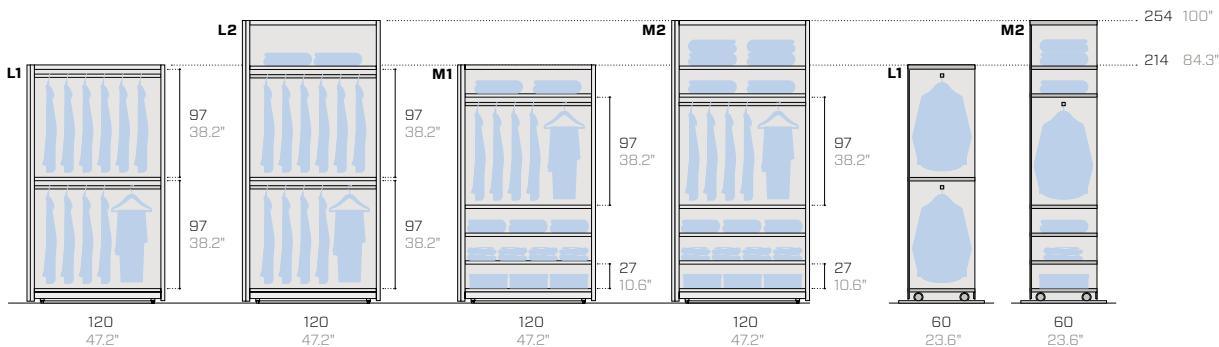

**Examples of composition L120 cm / Esempi di composizione L120 cm / Kompositionsbeispiele L120 cm**

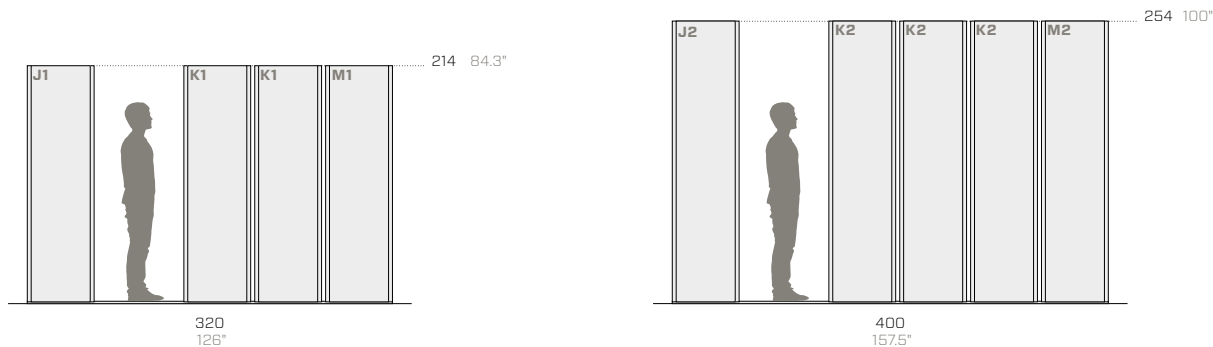

Covers / Cover / Verkleidung

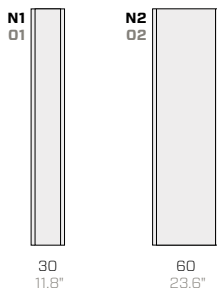

Only available for Binaria.  
Disponibili solo per Binaria.  
Nur für Binaria erhältlich.

Central partitions / Divisori centrali / Zentrale Trennelemente

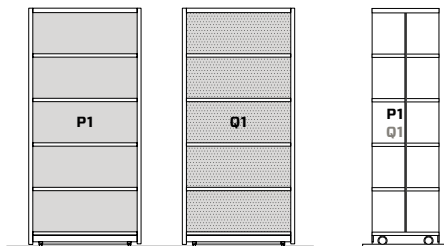

Q1 only available for H214 cm (84.3") with L80 cm or L100 cm (31.5" or 84.3").  
Q1 disponibile solo per H214 cm (84.3") con L80 cm o L100 cm (31.5" o 84.3").  
Q1 erhältlich nur für H214 cm (84.3") mit L80 cm oder L100 cm (31.5" oder 84.3").

Accessories / Accessori / Zubehör

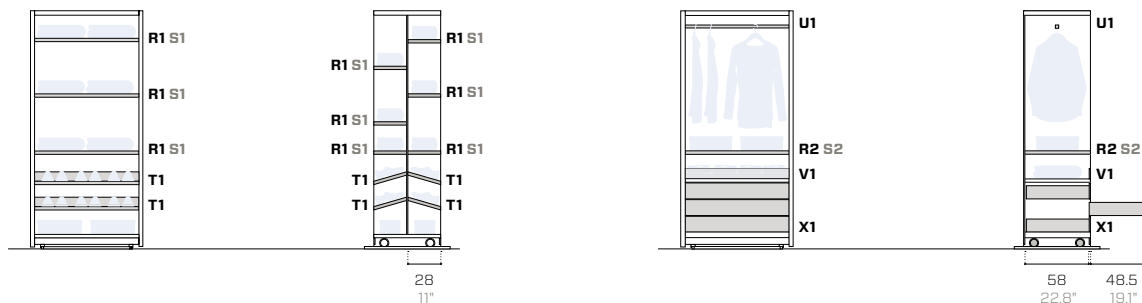

System closing and locking / Chiusura e blocco dell'impianto / Verschluss und Sperrung des Systems

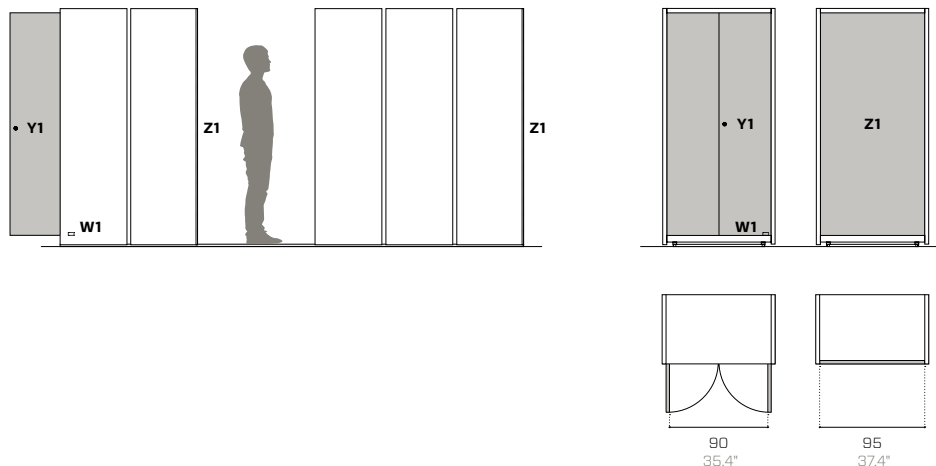

## Product / Prodotto / Produkt

## Packaging / Imballo / Verpackung

No.	Code	Dimensions (w-d-h)	Weight	Drawers	Dimensions (w-d-h)	Weight	Vol pkg	
Nr.	Codice	Dimensioni (l-p-h)	Peso	Cassetti	Dimensioni (l-p-h)	Peso	Vol. collo	
Nr.	Code	Abmessungen (b-t-h)	Gewicht	Schubladen	Abmessungen (b-t-h)	Gewicht	Vol. Kollo	
		cm	kg			cm	kg	mc

Binaria metal cover / Cover Binaria in metallo / Binaria Metallverkleidung

<b>N1</b>	-	30 3.5 -	-	-	-	-	-
<b>N2</b>	-	60 3.5 -	-	-	-	-	-

Binaria wooden cover / Cover Binaria in legno / Binaria Holzverkleidung

<b>O1</b>	-	30 3.5 -	-	-	-	-	-
<b>O2</b>	-	60 3.5 -	-	-	-	-	-

Blind central partition / Divisore centrale cieco / Zentrales, geschlossenes Trennelement

<b>P1</b>	-	- 1 -	-	-	-	-	-
-----------	---	-------	---	---	---	---	---

Perforated central partition (surcharge applies) / Divisore centrale forato (costo extra) / Zentrales, gelochtes Trennelement (mit Aufpreis)

<b>Q1</b>	-	- 1 214	-	-	-	-	-
-----------	---	---------	---	---	---	---	---

Metal shelf / Ripiano in metallo / Einlegeboden aus Metall

<b>R1</b>	-	- 30 2.6	-	-	-	-	-
<b>R2</b>	-	- 60 2.6	-	-	-	-	-

Wooden shelf (surcharge applies) / Ripiano in legno (costo extra) / Einlegeboden aus Holz (mit Aufpreis)

<b>S1</b>	-	- 30 2.6	-	-	-	-	-
<b>S2</b>	-	- 60 2.6	-	-	-	-	-

Shoe holder / Portascarpe / Schuhschrank

<b>T1</b>	-	- - -	-	-	-	-	-
-----------	---	-------	---	---	---	---	---

Clothes rail / Tubo appendiabiti / Kleiderstange

<b>U1</b>	-	- - 2.5	-	-	-	-	-
-----------	---	---------	---	---	---	---	---

Side piece / Spondina / Seitenstück

<b>V1</b>	-	- - -	-	-	-	-	-
-----------	---	-------	---	---	---	---	---

Chest of three drawers / Cassetiera a tre cassetti / Kommode mit drei Schubladen

<b>X1</b>	-	- 60 45	-	-	-	-	-
-----------	---	---------	---	---	---	---	---

Doors with lock / Ante con serratura / Tür mit Schloss

<b>Y1</b>	-	- - -	-	-	-	-	-
-----------	---	-------	---	---	---	---	---

System closing / Chiusura impianto / Systemverschluss

<b>W1</b>	FC2008LOC	- - -	-	-	-	-	-
-----------	-----------	-------	---	---	---	---	---

Blind side backboard / Schiena laterale cieca / Geschlossenes Seitenwand

<b>Z1</b>	-	- 1 -	-	-	-	-	-
-----------	---	-------	---	---	---	---	---

## Metal essentials

	<p><b>01.18</b> <b>Black (RAL 9005)</b> Nero / Schwarz --- <b>MT</b> <b>EM</b> ▲ ■</p>		<p><b>08.20</b> <b>Rose quartz</b> Rosa quarzo / Rosenquarz --- <b>EM</b> ▲</p>		<p><b>15.19</b> <b>Forest green (RAL 6007)</b> Verde bosco / Waldgrün --- <b>EM</b> ▲ ●</p>
	<p><b>02.18</b> <b>Anthracite (RAL 7021)</b> Antracite / Anthrazit --- <b>MT</b> <b>EM</b> ▲ ● ■</p>		<p><b>09.18</b> <b>Ruby red (RAL 3003)</b> Rosso rubino / Rubinrot --- <b>MT</b> <b>EM</b> ▲</p>		<p><b>16.19</b> <b>Turquoise blue (RAL 5018)</b> Blu turchese / Türkisblau --- <b>EM</b> ▲</p>
	<p><b>03.18</b> <b>Fantin grey</b> Grigio Fantin / Fantin-Grau --- <b>EM</b> ▲ ● ■</p>		<p><b>10.18</b> <b>Traffic red (RAL 3020)</b> Rosso traffico / Verkehrsrot --- <b>MT</b> <b>EM</b> ▲</p>		<p><b>17.18</b> <b>Pastel blue (RAL 5024)</b> Blu pastello / Pastellblau --- <b>MT</b> <b>EM</b> ▲ ●</p>
	<p><b>04.18</b> <b>Light grey (RAL 7035)</b> Grigio luce / Lichtgrau --- <b>MT</b> <b>EM</b> ▲ ■</p>		<p><b>11.18</b> <b>Pure orange (RAL 2004)</b> Arancio puro / Reinorange --- <b>MT</b> <b>EM</b> ▲</p>		<p><b>18.20</b> <b>Serenity</b> Serenity / Serenity --- <b>MT</b> <b>EM</b> ▲</p>
	<p><b>05.19</b> <b>Cloud grey</b> Grigio nuvola / Walkengrau --- <b>EM</b> ▲ ● ■</p>		<p><b>12.19</b> <b>Zinc yellow (RAL 1018)</b> Giallo zinco / Zincksgelb --- <b>EM</b> ▲</p>		<p><b>19.18</b> <b>Gentian blue (RAL 5010)</b> Blu genziana / Enzianblau --- <b>MT</b> <b>EM</b> ▲</p>
	<p><b>06.18</b> <b>White (RAL 9016)</b> Bianco / Weiß --- <b>MT</b> <b>EM</b> ▲ ■</p>		<p><b>13.19</b> <b>Mint green (RAL 6024)</b> Verde menta / Minzgrün --- <b>EM</b> ▲</p>		<p><b>20.19</b> <b>Steel blue (RAL 5011)</b> Blu acciaio / Stahlblau --- <b>EM</b> ▲</p>
	<p><b>07.18</b> <b>Pearl white (RAL 1013)</b> Bianco perla / Perlweiß --- <b>MT</b> <b>EM</b> ▲ ■</p>		<p><b>14.18</b> <b>Sage green (RAL 6021)</b> Verde salvia / Salbeigrün --- <b>MT</b> <b>EM</b> ▲</p>		

## Legend / Legenda / Legende

**MT** Matt / Opaco / Matt  
**EM** Embossed / Goffrato / Gaufriert

- ▲ For tops / Per i top / Für die Abdeckungen  
● For outdoor use / Per esterni / Für den Außenbereich  
■ For food use / Per uso alimentare / Für den Lebensmittelgebrauch



## Metal design\*

## Ultra-matt\*

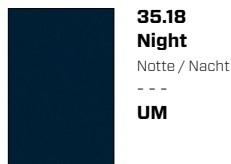
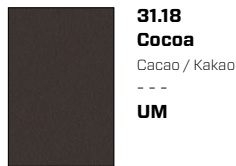

## Metallic\*

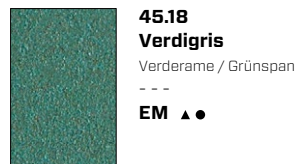
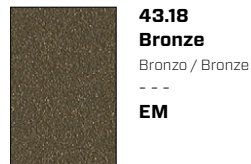
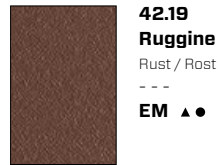
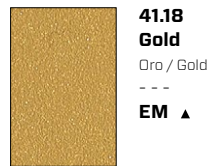

## Earth\*

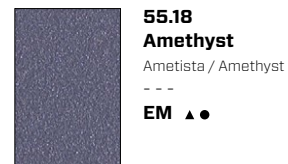
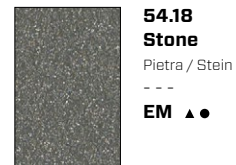
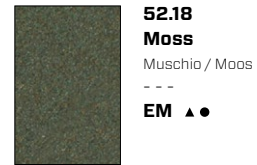

## Legend / Legenda / Legende

**UM** Ultra matt / Ultra opaco / Ultra matt

**EM** Embossed / Goffrato / Gaufriert

▲ For tops / Per i top / Für die Abdeckungen

● For outdoor use / Per esterni / Für den Außenbereich

**Wood**  
**Legno**  
**Holz**

**W1.18****Natural oak**

Rovere naturale / Eiche hell

---

**MT ▲****W3.18****Dark oak**

Rovere scuro / Eiche dun

---

**MT ▲****W5.18****Fir wood**

Abete / Fichte

---

**MT ▲**

**Melamine coated**  
**Nobilitato**  
**Melaminbeschichtet**

**M1.18****Grey**

Grigio / Grau

---

**EM ▲****M2.18****White**

Bianco / Weiß

---

**EM ▲****M4.18****Natural oak**

Rovere naturale / Eiche hell

---

**EM ▲**

---

**Legend / Legenda / Legende**

---

**MT** Matt / Opaco / Matt**EM** Embossed / Goffrato / Gaufriert

---

▲ For tops / Per i top / Für die Abdeckungen

---

### Technical information

**Metal** Non-toxic powder coating for interior use, with no heavy metals. Cured in an oven at 190°C, following degreasing and phosphating. Guaranteed minimum thickness of 50 microns. Minimum resistance to salt spray of 200 hours (in accordance with the ASTM B117 standard). Some finishes are suitable for direct contact with food as required by Italian Law Decree D.M. 21/03/73 and subsequent updates. Before the coating is added, it is possible to assess whether to give the products a special treatment to make them more resistant to wear and exposure to the elements. There is a surcharge for this treatment. Requests for other RAL finishes can be considered.

**Wood** Exquisite types of wood with veneers and under-leaf edges, on MDF structures. All panels are given an acrylic coating and are certified "formaldehyde free". Panck products are an exception because they are made with solid fir slats that are sanded and given a natural coating. Requests for other finishes for the wood will be considered.

**Melamine coated** Faced top with a fibre-board structure and a coloured or wood-effect melamine finish. Requests for other melamine finishes will be considered.

### Informazioni tecniche

**Metallo** Verniciatura per interni a polveri atossiche prive di metalli pesanti, con passaggio in forno a 190 °C, previo trattamento di sgrassaggio e fosfatazione. Spessore minimo garantito 50 micron, resistenza minima in nebbia salina pari a 200 ore (norma ASTM B117). Alcune finiture sono idonee al contatto diretto con alimenti come previsto dal decreto italiano D.M. 21/03/73 e successivi aggiornamenti. Prima della verniciatura, è possibile valutare l'applicazione di un trattamento al fine di rendere i prodotti più resistenti all'uso e all'esposizione agli agenti atmosferici. Per tale trattamento è prevista una maggiorazione di prezzo. Altre finiture RAL valutabili su richiesta.

**Legno** Pregiate essenze di legno impiallacciato con bordatura sottofoglia, su struttura in MDF. Tutti i pannelli ricevono una verniciatura acrilica e sono certificati "privi di formaldeide". Il prodotto Panck è un'eccezione in quanto è composto da doghe in massello di abete levigato e verniciato al naturale. Altre finiture in legno sono valutabili su richiesta.

**Nobilitato** Piano in nobilitato con struttura in pannello di fibre di legno rivestito da finiture melaminiche colorate o effetto legno. Altre finiture melaminiche sono valutabili su richiesta.

### Technische Informationen

**Metall** Die Pulverbeschichtung der gift- und schwermetalldfreien Pulverlacke für Innenbereiche erfolgt im Lackierofen bei 190 °C nach vorheriger Entfettung und Phosphatierung. Die garantierte Mindeststärke der Lackschicht beträgt 50 Mikron bei einer Mindestprüfungsdauer von 200 Stunden im Salznebel (ASTM-Norm B117). Einige Oberflächen sind für den direkten Kontakt mit Lebensmitteln geeignet, wie in der Verordnung vorgesehen Italienisch D.M. 21/03/73 und folgende Aktualisierungen. Vor der Pulverbeschichtung kann die Anwendung einer Behandlung abgewägt werden, um die Produkte für den Gebrauch und gegen Witterungseinflüsse widerstandsfähiger zu machen. Für diese Behandlung ist ein Preisaufschlag vorgesehen. Auf Anfrage können andere RAL-Finishes in Betracht gezogen werden.

**Holz** Hochwertiges Holzfurnier mit folienbedeckter Umrandung auf einer Struktur aus MDF Alle Paneele erhalten eine Acryllackierung und sind formaldehydfrei zertifiziert. Eine Ausnahme bildet das Produkt Panck, denn es besteht aus Holzplatten aus massivem, poliertem und natürlich lackiertem Fichtenholz. Andere Holzfinishes können auf Anfrage abgewägt werden.

**Melaminbeschichtet** Melaminbeschichtete Tischplatte bestehend aus einer Holzfaserverplatte, die mit farbigen Melaminfinishes oder Holzeffektfinishes überzogen ist. Andere Melaminfinishes können auf Anfrage abgewägt werden.

### A little piece of internal architecture that will take centre stage.

**Platform** made of laminate fibreboard (white or grey) with stainless steel perimeter rails. Height: 20 mm (0.79"). No need of floor fixing.

**Wheels and bases:** 60 x 40 x 2 mm (2.36" x 1.57" x 0.08") welded tube with steel wheels with a diameter of 65 mm (2.56") on shielded ball bearings.

**Reinforced 35 mm (1.38") sides** with vertical groove handles. They can be customized in all of Fantin's metal and wood finishes and in accordance with requests.

**Ceilings** for the top without intermediate gaps, thickness 0.7 mm (0.03").

**Blind or micro-perforated bracing panels** made of 1 mm (0.04") sheet metal, centrally located on each module.

**Shelf brackets** with a thickness of 1.5 mm (0.06") to provide a support surface without a gap between the sides and the shelves.

**Shelves** made of 0.7 mm (0.03") thick sheet metal with triple bends on the two front sides and omega reinforcements for an evenly distributed maximum load of 100 kg (220.5 lb). Independent, variable positioning with intervals of 5 cm (1.97"). Filing units and side pieces can be added. Customizable on request.

**Hinged doors** made of hollow-core sheet metal with locks and concealed hinges.

**Manual sliding.**

**Safety systems:** for units over 2.5 m (8'2") in height – and other units on request – a tubular telescopic anti-tilt system is fitted above the ceilings.

**The entire unit can be closed** with a blocking system on the last module.

**Optional accessories:** bridge with LED lighting all along the sliding length of the unit. Available H = 214 cm (7") and T less than 380 cm (12'6") only.

This product is delivered unassembled.

### Una piccola architettura da interni, protagonista al centro della scena.

**Pedana** in pannello di fibre di legno laminato (bianco o grigio) con rotaie in acciaio inox perimetrali. Altezza 20 mm (0.79"). Non necessita di fissaggio a pavimento.

**Ruote e basamenti:** tubolare saldato 60 x 40 x 2 mm (2.36" x 1.58" x 0.08"), dotato di ruote in acciaio diametro 65 mm (2.56") montate su cuscinetti a sfera schermati.

**Fiancate** rinforzate da 35 mm (1.38"), con prese maniglie a gola verticale. Personalizzabili in tutte le finiture Fantin – metallo e legno – e su richiesta.

**Cieli** di chiusura superiore senza fessurazioni intermedie, di spessore 0.7 mm (0.03").

**Pannelli di controventatura** ciechi o microforati in lamiera 1 mm (0.04"), in posizione centrale su ogni modulo.

**Staffe di fissaggio** dei ripiani di spessore 1.5 mm (0.06") che permettono una superficie di appoggio senza spazio tra fiancata e ripiano.

**Ripiani** in lamiera di spessore 0.7 mm (0.03"), triplice piegatura sui due lati frontali, con rinforzi ad omega per un carico massimo di 100 kg (220.5 lb) uniformemente distribuiti. Posizionamento variabile e indipendente con passo 5 cm (1.97"), integrabili con profili portacartelle e spondine. Personalizzazioni su richiesta.

**Porte anta battente** in lamiera tamburata prive di cerniere in vista e con serratura.

**Traslazione** manuale.

**Sistemi di sicurezza:** per gli impianti oltre i 2.5 m di altezza – e quando richiesto – è previsto un dispositivo di antiribaltamento in tubolare telescopico, montato sopra i cieli.

**Chiusura dell'intero impianto** mediante sistema di bloccaggio sull'ultimo modulo.

**Accessori opzionali:** ponte con illuminazione a led su tutta la lunghezza di traslazione dell'impianto. Disponibile H = 214 cm (7") e T minore di 380 cm (12'6").

Il prodotto viene fornito smontato.

### Eine kleine Innenarchitektur Protagonist im Zentrum der Szene.

**Trittläche** aus laminiertem Holzfaserpaneel (weiß oder grau) mit umlaufenden Schienen aus rostfreiem Edelstahl. Höhe 20 mm (0.79"). Keine Bodenbefestigung notwendig.

**Rollen und Untergestelle:** verschweißte Metallrohren 60 x 40 x 2 mm (2.36" x 1.58" x 0.08") versehen mit Stahlrollen, Durchmesser 65 mm (2.56"), die auf abgedichtete Kugellager montiert sind.

**Verstärkte Seitenwände** 35 mm (1.38") mit Handgriff mit vertikaler Kehlung. Alle Fantin-Finishs, sowohl Metall als auch Holz, sind individualisierbar, auch auf Anfrage.

**Obere Abdeckungen**, 0.7 mm (0.03") stark und ohne Zwischenspalten.

**Verstärkungs-Blindpaneele** oder Lochbleche 1 mm (0.04") in zentraler Position an jedem Modul.

**Befestigungsbügel** der 1.5 mm (0.06") starken Einlegeböden schaffen eine durchgehende Ablagefläche ohne Abstand zwischen Seitenwand und Einlegeboden.

**Blech-Einlegebögen**, 0.7 mm (0.03") stark, dreifacher Falz an beiden Vorderseiten mit Omega-Verstärkung für eine gleichmäßig verteilte maximale Traglast von 100 kg (220.5 lb). Variable und unabhängige Positionierung mit einem Abstand von 5 cm (1.97"), ergänzbar mit Hängemappenprofilen und Seitenwänden. Personalisierungen auf Anfrage.

**Flügeltür** aus glattem Blech ohne sichtbare Scharniere und mit Schloss.

**Manuelle Verschiebung.**

**Sicherheitssysteme:** Für die über 2.5 m hohen Anlagen, und wenn verlangt, ist eine Kippschutzvorrichtung aus Teleskoprohr vorgesehen, die über den Abdeckungen montiert wird.

**Verschluss der gesamten Schrankanlage** mittels Verriegelungssystem am letzten Modul.

**Optionales Zubehör:** Brücke mit LED-Beleuchtung über die gesamte Verschiebungslänge der Anlage. Nur H = 214 cm (7") und T weniger als 380 cm (12'6") verfügbar.

Das Produkt wird unmontiert geliefert.

---

**Disclaimer / Esclusione di responsabilità / Haftungsausschluss**

Fantin Srl reserves the right to change the dimensions and features of the products contained in this technical data sheet at any time and without prior notice. The finishes illustrated are purely indicative as the accuracy tolerances of printing processes should be taken into account.

Fantin Srl si riserva la facoltà di modificare in qualsiasi momento e senza preavviso le dimensioni e l'esecuzione dei prodotti contenuti nella presente scheda tecnica. Le finiture riportate hanno valore indicativo in quanto soggette alle tolleranze dei processi di stampa.

Fantin Srl behält sich das Recht vor, die angegebenen Maße und Ausführungen der Produkte, welche dieses Produktblatt enthält, jederzeit ohne Vorankündigung zu ändern. Aufgrund drucktechnischer Abweichungen dienen die dargestellten Ausführungen nur der Illustration.

---

**Fantin Srl**

via San Vito, 43  
33080 - Bannia  
di Fiume Veneto (PN)  
Italia

t +39 0434 959 133  
f +39 0434 560 037  
fantin@fantin.com  
www.fantin.com



UNI EN ISO 9001