

Pillar

Salvatore Indriolo, 2016

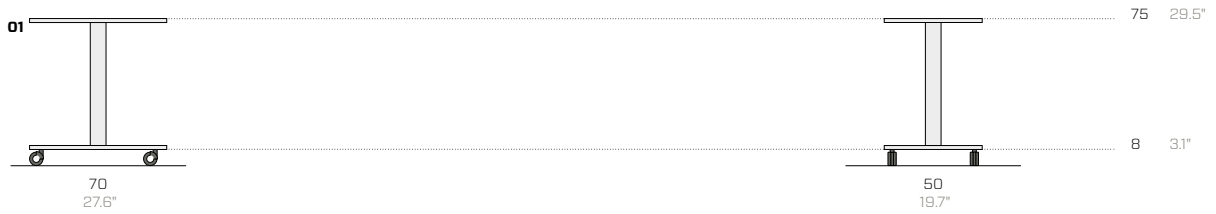

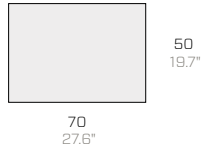

Side pieces / Spondine / Seitenwände

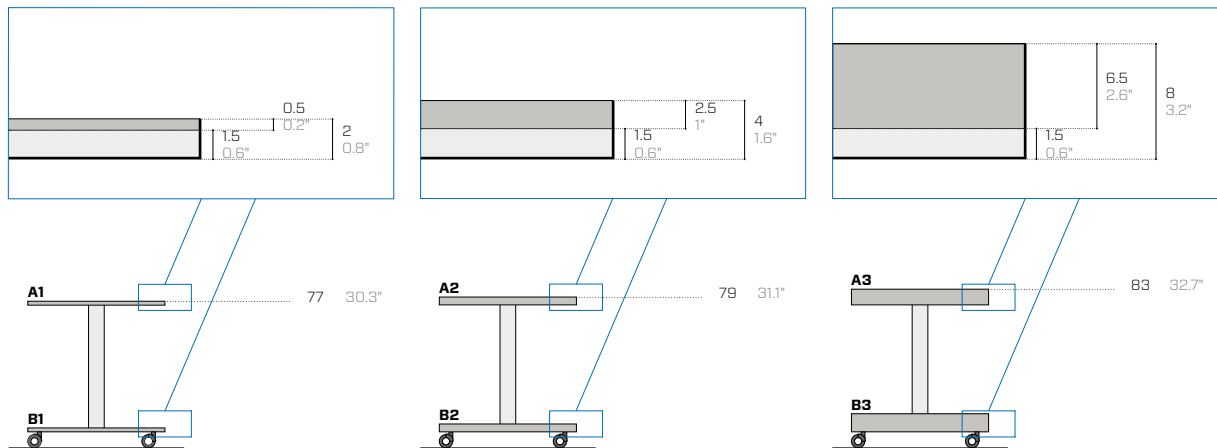

Examples of compositions / Esempi di composizioni / Kompositionsbeispiele

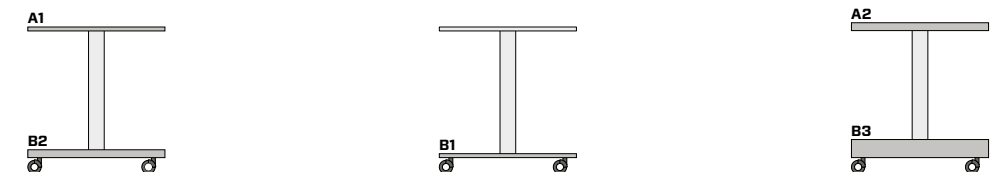

Product / Prodotto / Produkt

Packaging / Imballo / Verpackung

No.	Code	Dimensions (w-d-h)	Weight	Max capacity	Dimensions (w-d-h)	Weight	Vol pkg
N.	Codice	Dimensioni (l-p-h)	Peso	Capacità max	Dimensioni (l-p-h)	Peso	Vol. collo
Nr.	Code	Abmessungen (b-t-h)	Gewicht	Max. Tragfähigkeit	Abmessungen (b-t-h)	Gewicht	Vol. Kollo
		cm	kg	kg	cm	kg	mc

01	FPL01	70 50 75	21	40	71 51 87	28	0.32
-----------	--------------	----------	----	----	----------	----	------

Upper side pieces / Spondine superiori / Obere Seitenwände

A1	FPL01CS20	70.5 50.5 2	4.8	-	- - -	-	0.01
A2	FPL01CS40	70.5 50.5 4	5.4	-	- - -	-	0.02
A3	FPL01CS80	70.5 50.5 8	6.7	-	- - -	-	0.03

Lower side pieces / Spondine inferiori / Untere Seitenwände

B1	FPL01CI20	70.5 50.5 2	4.8	-	- - -	-	0.01
B2	FPL01CI40	70.5 50.5 4	5.4	-	- - -	-	0.02
B3	FPL01CI80	70.5 50.5 8	6.7	-	- - -	-	0.03

Wooden upper facing (only with side pieces) / Rivestimento superiore in legno (solo con spondine) / Obere Verkleidung aus Holz (nur mit Seitenwänden)

-	FPL01RSL	70 50 1	1	-	- - -	-	-
---	-----------------	---------	---	---	-------	---	---

Wooden lower facing (only with side pieces) / Rivestimento inferiore in legno (solo con spondine) / Untere Verkleidung aus Holz (nur mit Seitenwänden)

-	FPL01RIL	70 50 1	1	-	- - -	-	-
---	-----------------	---------	---	---	-------	---	---

The packaging details are for assembled products / I dati di imballo si riferiscono al prodotto montato / Die Verpackungsdaten beziehen sich auf das montierte Produkt



Metal essentials

	<p>01.18 Black (RAL 9005) Nero / Schwarz --- MT EM ▲ ■</p>		<p>08.20 Rose quartz Rosa quarzo / Rosenquarz --- EM ▲</p>		<p>15.19 Forest green (RAL 6007) Verde bosco / Waldgrün --- EM ▲ ●</p>
	<p>02.18 Anthracite (RAL 7021) Antracite / Anthrazit --- MT EM ▲ ● ■</p>		<p>09.18 Ruby red (RAL 3003) Rosso rubino / Rubinrot --- MT EM ▲</p>		<p>16.19 Turquoise blue (RAL 5018) Blu turchese / Türkisblau --- EM ▲</p>
	<p>03.18 Fantin grey Grigio Fantin / Fantin-Grau --- EM ▲ ● ■</p>		<p>10.18 Traffic red (RAL 3020) Rosso traffico / Verkehrsrot --- MT EM ▲</p>		<p>17.18 Pastel blue (RAL 5024) Blu pastello / Pastellblau --- MT EM ▲ ●</p>
	<p>04.18 Light grey (RAL 7035) Grigio luce / Lichtgrau --- MT EM ▲ ■</p>		<p>11.18 Pure orange (RAL 2004) Arancio puro / Reinorange --- MT EM ▲</p>		<p>18.20 Serenity Serenity / Serenity --- MT EM ▲</p>
	<p>05.19 Cloud grey Grigio nuvola / Wolkengrau --- EM ▲ ● ■</p>		<p>12.19 Zinc yellow (RAL 1018) Giallo zinco / Zincksgelb --- EM ▲</p>		<p>19.18 Gentian blue (RAL 5010) Blu genziana / Enzianblau --- MT EM ▲</p>
	<p>06.18 White (RAL 9016) Bianco / Weiß --- MT EM ▲ ■</p>		<p>13.19 Mint green (RAL 6024) Verde menta / Minzgrün --- EM ▲</p>		<p>20.19 Steel blue (RAL 5011) Blu acciaio / Stahlblau --- EM ▲</p>
	<p>07.18 Pearl white (RAL 1013) Bianco perla / Perlweiß --- MT EM ▲ ■</p>		<p>14.18 Sage green (RAL 6021) Verde salvia / Salbeigrün --- MT EM ▲</p>		

Legend / Legenda / Legende

MT Matt / Opaco / Matt

EM Embossed / Goffrato / Gaufriert

▲ For tops / Per i top / Für die Abdeckungen

● For outdoor use / Per esterni / Für den Außenbereich

■ For food use / Per uso alimentare / Für den
Lebensmittelgebrauch

Metal design*

Ultra-matt*

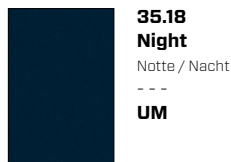
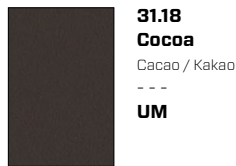

Metallic*

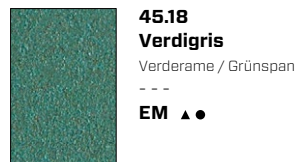
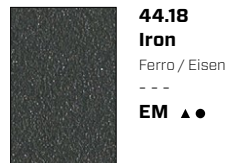
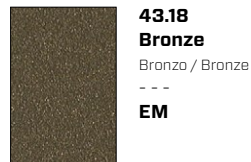
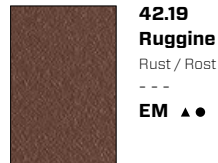
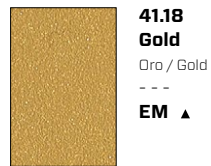

Earth*

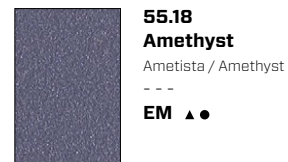
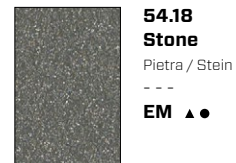
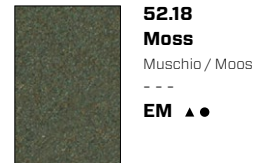

Legend / Legenda / Legende

UM Ultra matt / Ultra opaco / Ultra matt

EM Embossed / Goffrato / Gaufriert

▲ For tops / Per i top / Für die Abdeckungen

● For outdoor use / Per esterni / Für den Außenbereich

Wood
Legno
Holz



W1.18

Natural oak

Rovere naturale / Eiche hell

MT ▲



W3.18

Dark oak

Rovere scuro / Eiche dun

MT ▲



W5.18

Fir wood

Abete / Fichte

MT ▲

Legend / Legenda / Legende

MT Matt / Opaco / Matt

▲ For tops / Per i top / Für die Abdeckungen

Technical information

Metal Non-toxic powder coating for interior use, with no heavy metals. Cured in an oven at 190°C, following degreasing and phosphating. Guaranteed minimum thickness of 50 microns. Minimum resistance to salt spray of 200 hours (in accordance with the ASTM B117 standard). Some finishes are suitable for direct contact with food as required by Italian Law Decree D.M. 21/03/73 and subsequent updates. Before the coating is added, it is possible to assess whether to give the products a special treatment to make them more resistant to wear and exposure to the elements. There is a surcharge for this treatment. Requests for other RAL finishes can be considered.

Wood Exquisite types of wood with veneers and under-leaf edges, on MDF structures. All panels are given an acrylic coating and are certified "formaldehyde free". Panck products are an exception because they are made with solid fir slats that are sanded and given a natural coating. Requests for other finishes for the wood will be considered.

Informazioni tecniche

Metallo Verniciatura per interni a polveri atossiche prive di metalli pesanti, con passaggio in forno a 190 °C, previo trattamento di sgrassaggio e fosfatazione. Spessore minimo garantito 50 micron, resistenza minima in nebbia salina pari a 200 ore (norma ASTM B117). Alcune finiture sono idonee al contatto diretto con alimenti come previsto dal decreto italiano D.M. 21/03/73 e successivi aggiornamenti. Prima della verniciatura, è possibile valutare l'applicazione di un trattamento al fine di rendere i prodotti più resistenti all'uso e all'esposizione agli agenti atmosferici. Per tale trattamento è prevista una maggiorazione di prezzo. Altre finiture RAL valutabili su richiesta.

Legno Pregiate essenze di legno impiallacciato con bordatura sottofoglia, su struttura in MDF. Tutti i pannelli ricevono una verniciatura acrilica e sono certificati "privi di formaldeide". Il prodotto Panck è un'eccezione in quanto è composto da doghe in massello di abete levigato e verniciato al naturale. Altre finiture in legno sono valutabili su richiesta.

Technische Informationen

Metall Die Pulverbeschichtung der gift- und schwermetalldfreien Pulverlacke für Innenbereiche erfolgt im Lackierofen bei 190 °C nach vorheriger Entfettung und Phosphatierung. Die garantierte Mindeststärke der Lackschicht beträgt 50 Mikron bei einer Mindestprüfungsdauer von 200 Stunden im Salznebel (ASTM-Norm B117). Einige Oberflächen sind für den direkten Kontakt mit Lebensmitteln geeignet, wie in der Verordnung vorgesehen Italienisch D.M. 21/03/73 und folgende Aktualisierungen. Vor der Pulverbeschichtung kann die Anwendung einer Behandlung abgewägt werden, um die Produkte für den Gebrauch und gegen Witterungseinflüsse widerstandsfähiger zu machen. Für diese Behandlung ist ein Preisaufschlag vorgesehen. Auf Anfrage können andere RAL-Finishes in Betracht gezogen werden.

Holz Hochwertiges Holzfurnier mit folienbedeckter Umrandung auf einer Struktur aus MDF Alle Paneele erhalten eine Acryl-Lackierung und sind formaldehydfrei zertifiziert. Eine Ausnahme bildet das Produkt Panck, denn es besteht aus Holzplatten aus massivem, poliertem und natürlich lackiertem Fichtenholz. Andere Holzfinishes können auf Anfrage abgewägt werden.

A trolley that only settles for the best: four wheels, two shelves and a sturdy support post. A handy, practical accessory with an iconic shape.

Black or white rubber castors with a diameter of 65 mm (2.56"), with a galvanized steel support. Overall trolley capacity: 200 kg (440.9 lb).

Sheet metal tops of 1.5 mm (0.06") and 15 mm (0.59") in thickness. Dimensions of all tops: 500 x 700 mm (19.69" x 27.56").

Veneered wooden top on an aluminium structure.

Support post consisting of a tube with a diameter of 80 mm (3.15") and attachment plates.

Optional side pieces made of 1.5 mm (0.06") thick sheet metal for both tops in the following forms: height 20 mm (0.79") with a 5 mm (0.20") lipped edge, height 40 mm (1.57") with a 25 mm (0.98") lipped edge and height 80 mm (3.15") with a 65 mm (2.56") lipped edge. Lipped edges on all sides.

[This product is ready assembled \(flat packs are only provided on request\).](#)

Un carrello senza compromessi: quattro ruote, due ripiani e una robusta colonna portante. Una forma iconica per un accessorio utile e comodo.

Ruote girevoli in gomma nera o bianca diametro 65 mm (2.56"), con supporto in lamiera d'acciaio zincata. Portata carrello: 200 kg (440.9 lb).

Piani in lamiera da 1.5 mm (0.06") e di spessore 15 mm (0.59"). Misura unica dei piani: 500 x 700 mm (19.69" x 27.56").

Piano in legno impiallacciato su struttura in alluminio.

Colonna portante in tubo diametro 80 mm (3.15") con piastre di aggancio.

Spondine opzionali in lamiera di spessore 1.5 mm (0.06") per entrambi i piani nelle seguenti versioni: altezza 20 mm (0.79") con bordo di battuta di 5 mm (0.20"), altezza 40 mm (1.58") con bordo di battuta di 25 mm (0.98") e altezza 80 mm (3.15") con bordo di battuta di 65 mm (2.56"). Bordi di battuta su tutti i lati.

[Il prodotto viene fornito montato \(smontato solo su richiesta\).](#)

Ein Wagen ohne Kompromisse: vier Rollen, zwei Einlegeböden und eine robuste Trägersäule. Eine legendäre Form für ein nützliches und komfortables Zubehör.

Drehrollen aus schwarzem oder weißem Gummi, Durchmesser 65 mm (2.56"), Halterung aus verzinktem Stahlblech. Gesamttragfähigkeit des Wagens 200 kg (440.9 lb).

Blechplatten 1.5 mm (0.06") und eine Stärke von 15 mm (0.59"). Einheitsgröße der Platten: 500 x 700 mm (19.69" x 27.56").

Holz furnierplatte auf Alustruktur.

Trägersäule aus Metallrohr Durchmesser 80 mm (3.15") mit Befestigungsplatten.

Optionale Seitenwände aus 1.5 mm (0.06") starkem Blech für beide Platten in den folgenden Ausführungen: Höhe 20 mm (0.79") mit Anschlagkante 5 mm (0.20"), Höhe 40 mm (1.58") mit Anschlagkante 25 mm (0.98") und Höhe 80 mm (3.15") mit Anschlagkante 65 mm (2.56"). Anschlagkanten an allen Seiten.

[Das Produkt wird montiert geliefert \(unmontiert nur auf Anfrage\).](#)

Disclaimer / Esclusione di responsabilità / Haftungsausschluss

Fantin Srl reserves the right to change the dimensions and features of the products contained in this technical data sheet at any time and without prior notice. The finishes illustrated are purely indicative as the accuracy tolerances of printing processes should be taken into account.

Fantin Srl si riserva la facoltà di modificare in qualsiasi momento e senza preavviso le dimensioni e l'esecuzione dei prodotti contenuti nella presente scheda tecnica. Le finiture riportate hanno valore indicativo in quanto soggette alle tolleranze dei processi di stampa.

Fantin Srl behält sich das Recht vor, die angegebenen Maße und Ausführungen der Produkte, welche dieses Produktblatt enthält, jederzeit ohne Vorankündigung zu ändern. Aufgrund drucktechnischer Abweichungen dienen die dargestellten Ausführungen nur der Illustration.

Fantin Srl

via San Vito, 43
33080 - Bannia
di Fiume Veneto (PN)
Italia

t +39 0434 959 133
f +39 0434 560 037
fantin@fantin.com
www.fantin.com



UNI EN ISO 9001