

Frame

Kitchens & workbenches

Salvatore Indriolo, 2018-20



archiproducts
DESIGN AWARDS
—
WINNER 2018



Bases / Basi / Basen

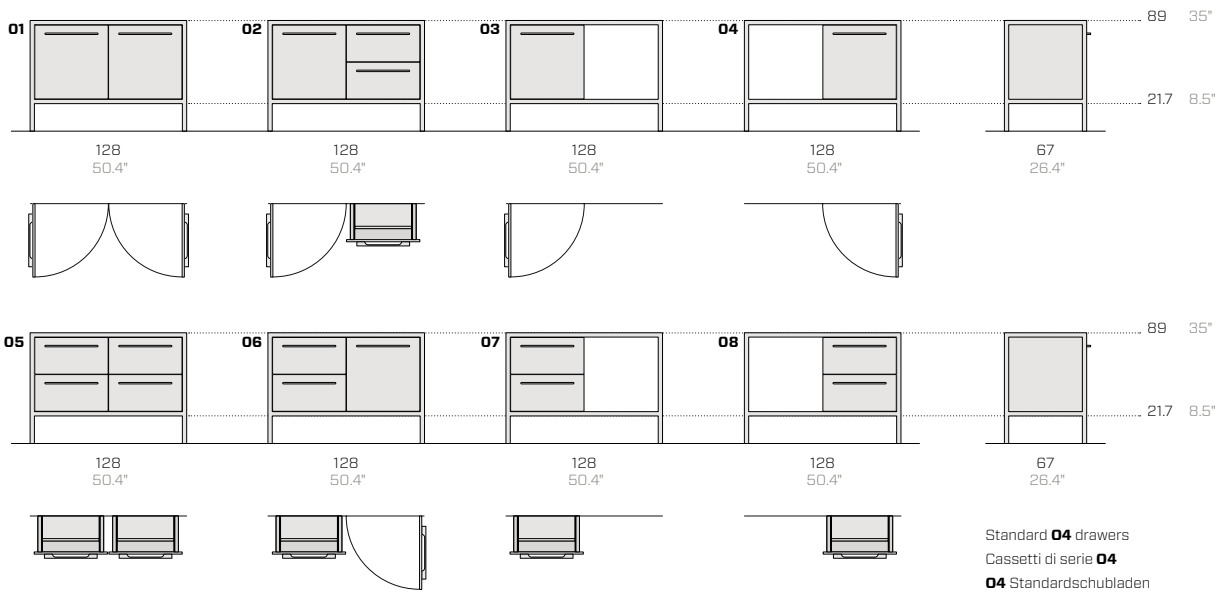

Top / Top / Arbeitsplatten

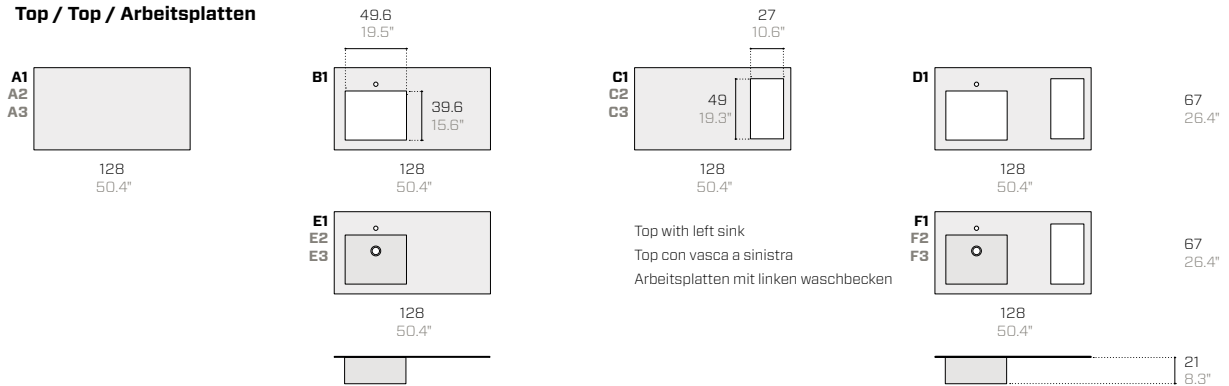

Useful measurements / Quote utili / Andere Maßen

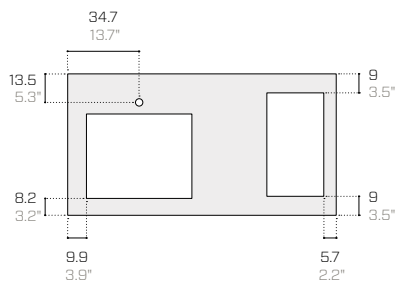

Wheel kit / Kit ruote / Radsatz



Product / Prodotto / Produkt

Packaging / Imballo / Verpackung

No.	Code	Dimensions (w-d-h)			Weight	Dimensions (w-d-h)			Weight	Vol pkg
N.	Codice	Dimensioni (l-p-h)			Peso	Dimensioni (l-p-h)			Peso	Vol. collo
Nr.	Code	Abmessungen (b-t-h)			Gewicht	Abmessungen (b-t-h)			Gewicht	Vol. Kollo
		cm			kg	cm			kg	mc

Bases / Basi / Basen

01	FR85	128	67	89	60	150	80	107	92	1.30
02	FR91D	128	67	89	70	150	80	107	102	1.30
03	FR84S	128	67	89	55	150	80	107	87	1.30
04	FR84D	128	67	89	55	150	80	107	87	1.30
05	FR93	128	67	89	60	150	80	107	112	1.30
06	FR91S	128	67	89	70	150	80	107	102	1.30
07	FR92S	128	67	89	65	150	80	107	97	1.30
08	FR92D	128	67	89	65	150	80	107	97	1.30

Top made of Fenix / Top in Fenix / Arbeitsplatte aus Fenix

A1	FRB21F	128	67	1.2	16	143	82	17	21	0.20
B1	FRB22F	128	67	1.2	15	143	82	17	20	0.20
C1	FRB23F	128	67	1.2	15	143	82	17	20	0.20
D1	FRB24F	128	67	1.2	14	143	82	17	19	0.20
E1	FRB25F	128	67	1.2	20	143	82	30	25	0.40
F1	FRB26F	128	67	1.2	20	143	82	30	25	0.40

Satin finish stainless steel top (Barazza) / Top in acciaio Inox satinato (Barazza) / Arbeitsplatte aus Edelstahl mit Satin-Finish (Barazza)

A2	FRB31S	128	67	0.4	27	137	80	21	37	0.30
C2	FRB33S	128	67	0.4	23	137	80	21	33	0.30
E2	FRB35S	128	67	0.4	25	137	80	50	35	0.60
F2	FRB36S	128	67	0.4	22	137	80	50	32	0.60

Vintage finish stainless steel top (Barazza) / Top in acciaio Inox Vintage (Barazza) / Arbeitsplatte aus Edelstahl mit Vintage-Finish (Barazza)

A3	FRB41V	128	67	0.4	27	137	80	21	37	0.30
C3	FRB43V	128	67	0.4	23	137	80	21	33	0.30
E3	FRB45V	128	67	0.4	25	137	80	50	35	0.60
F3	FRB46V	128	67	0.4	22	137	80	50	32	0.60

Back panel for freestanding kitchen / Schiena per cucina freestanding / Rückwand für freistehende Küche

-	FRK01S1	120	3	60	6	124	64	7	7	0.10
---	---------	-----	---	----	---	-----	----	---	---	------

Floor attachment cover kit / Kit di copertura allacciamenti a pavimento / Set für Abdeckung der Anschlüsse am Boden

-	FRK03A1	60	20	25	3	62	22	27	5	0.10
---	---------	----	----	----	---	----	----	----	---	------

Wheel kit with colour-matching discs / Kit ruote con dischi in tinta / Radsatz mit farblich abgestimmten Scheiben

G	FRK31R8	8	3.5	10	2	20	10	10	3	0.10
----------	---------	---	-----	----	---	----	----	----	---	------

Upstand (stainless steel, satin and Vintage finish) / Alzatina (acciaio inox, satinato o Vintage) / Wischleiste (Edelstahl, satin- und Vintage-Finish)

-	FRB81S	128	0.4	4	2.5	137	2	10	3	0.10
-	FRB81V	128	0.4	4	2.5	137	2	10	3	0.10

Bases / Basi / Basen

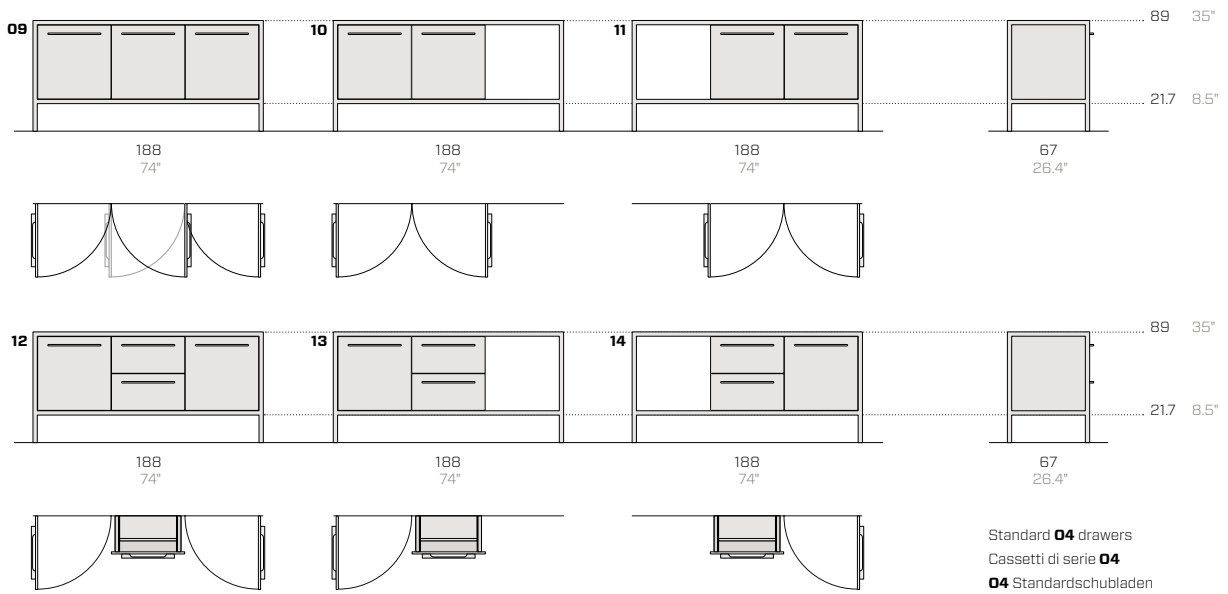

Top / Top / Arbeitsplatten

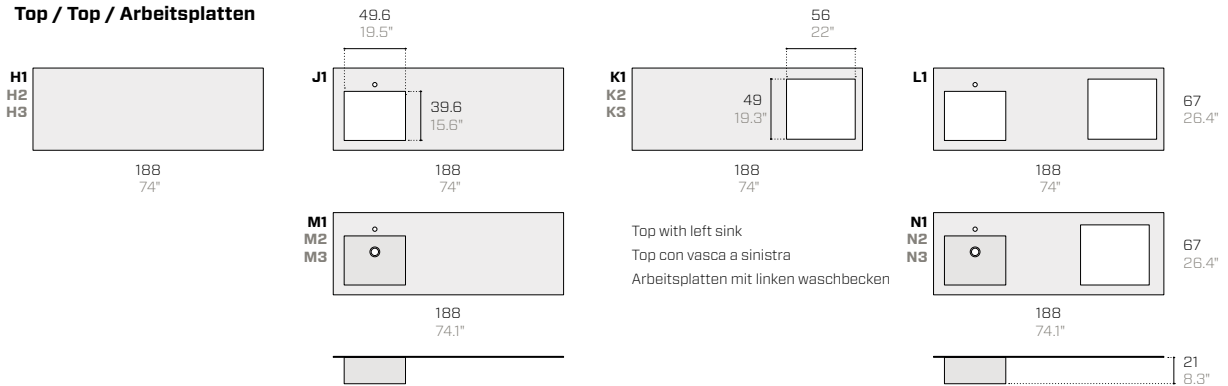

Useful measurements / Quote utili / Andere Maßen

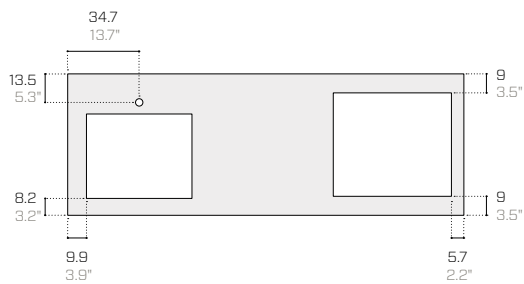

Top thickness / Spessore dei top / Stärke der Arbeitsplatten

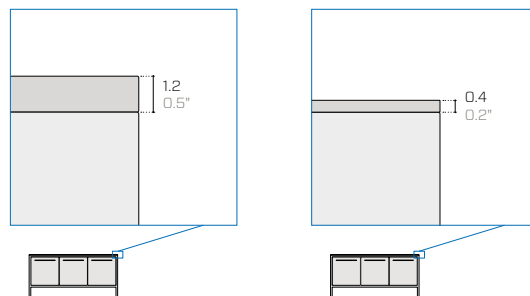

Top made of Fenix
Top in Fenix
Arbeitsplatte aus Fenix

Stainless steel top
Top in acciaio
Arbeitsplatte aus Edelstahl

Product / Prodotto / Produkt

Packaging / Imballo / Verpackung

No.	Code	Dimensions (w-d-h)	Weight	Dimensions (w-d-h)	Weight	Vol pkg
Nr.	Codice	Dimensioni (l-p-h)	Peso	Dimensioni (l-p-h)	Peso	Vol. collo
Nr.	Code	Abmessungen (b-t-h)	Gewicht	Abmessungen (b-t-h)	Gewicht	Vol. Kollo
		cm	kg	cm	kg	mc

Bases / Basi / Basen

09	FR87	188 67 89	92	200 80 107	135	1.80
10	FR86S	188 67 89	87	200 80 107	130	1.80
11	FR86D	188 67 89	87	200 80 107	130	1.80
12	FR83	188 67 89	102	200 80 107	145	1.80
13	FR82S	188 67 89	97	200 80 107	140	1.80
14	FR82D	188 67 89	97	200 80 107	140	1.80

Top made of Fenix / Top in Fenix / Arbeitsplatte aus Fenix

H1	FRB51F	188 67 1.2	23	203 82 17	28	0.30
J1	FRB52F	188 67 1.2	22	203 82 17	27	0.30
K1	FRB53F	188 67 1.2	22	203 82 17	27	0.30
L1	FRB54F	188 67 1.2	21	203 82 17	26	0.30
M1	FRB55F	188 67 1.2	26	203 82 30	31	0.50
N1	FRB56F	188 67 1.2	26	203 82 30	31	0.50

Satin finish stainless steel top (Barazza) / Top in acciaio Inox satinato (Barazza) / Arbeitsplatte aus Edelstahl mit Satin-Finish (Barazza)

H2	FRB61S	188 67 0.4	40	197 80 21	50	0.40
K2	FRB63S	188 67 0.4	31	197 80 21	41	0.40
M2	FRB65S	188 67 0.4	38	197 80 50	48	0.80
N2	FRB66S	188 67 0.4	30	197 80 50	40	0.80

Vintage finish stainless steel top (Barazza) / Top in acciaio Inox Vintage (Barazza) / Arbeitsplatte aus Edelstahl mit Vintage-Finish (Barazza)

H3	FRB71V	188 67 0.4	40	197 80 21	50	0.40
K3	FRB73V	188 67 0.4	31	197 80 21	41	0.40
M3	FRB75V	188 67 0.4	38	197 80 50	48	0.80
N3	FRB76V	188 67 0.4	30	197 80 50	40	0.80

Back panel for freestanding kitchen / Schiena per cucina freestanding / Rückwand für freistehende Küche

-	FRK02S2	180 3 60	9	184 64 7	10	0.10
---	---------	----------	---	----------	----	------

Floor attachment cover kit / Kit di copertura allacciamenti a pavimento / Set für Abdeckung der Anschlüsse am Boden

-	FRK03A1	60 20 25	3	62 22 27	5	0.10
---	---------	----------	---	----------	---	------

Wheel kit with colour-matching discs / Kit ruote con dischi in tinta / Radsatz mit farblich abgestimmten Scheiben

-	FRK31R8	8 3.5 10	2	20 10 10	3	0.10
---	---------	----------	---	----------	---	------

Upstand (stainless steel, satin and Vintage finish) / Alzatina (acciaio inox, satinato o Vintage) / Wischleiste (Edelstahl, satin- und Vintage-Finish)

-	FRB82S	188 0.4 4	3.5	197 2 10	4	0.10
-	FRB82V	188 0.4 4	3.5	197 2 10	4	0.10

Drawer kits / Kit cassetti / Schubladen-Set

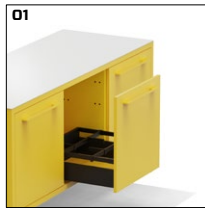
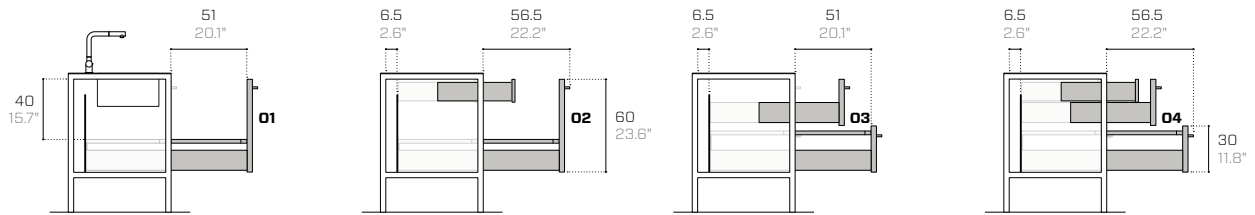

01
Kit 1 large drawer
Kit 1 cassettone
Set 1 Kommode

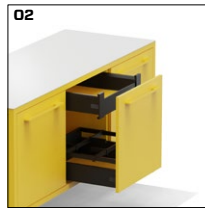

02
Kit 1 large drawer + 1 inner drawer
Kit 1 cassettone + cassetto interno
Set 1 Kommode + 1 Innenfach

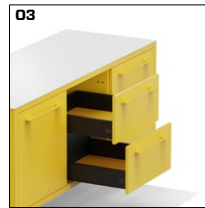

03
Kit 2 drawers
Kit 2 cassetti
Set 2 Schubladen

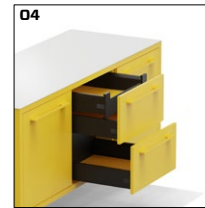

04
Kit 2 drawers + 1 inner drawer
Kit 2 cassetti + cassetto interno
Set 2 Schubladen + 1 Innenfach

Solid sheet metal wall panelling with shelf / Boiserie a muro in lamiera piena con mensola / Wandverkleidungen aus Vollblech mit Regal

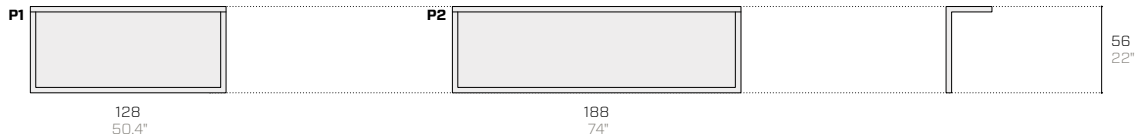

Perforated sheet metal wall panelling with shelf / Boiserie a muro in lamiera forata con mensola / Wandverkleidungen aus Lochblech mit Regal

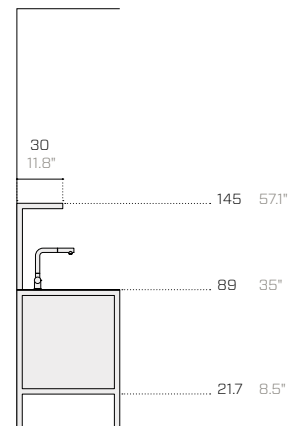
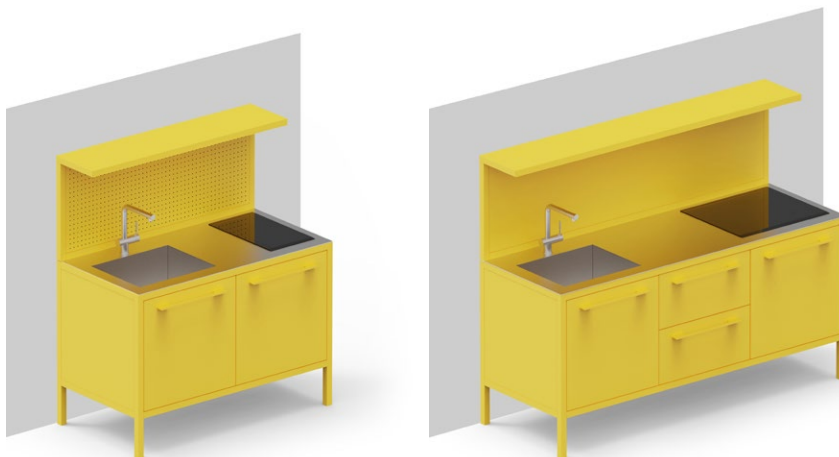
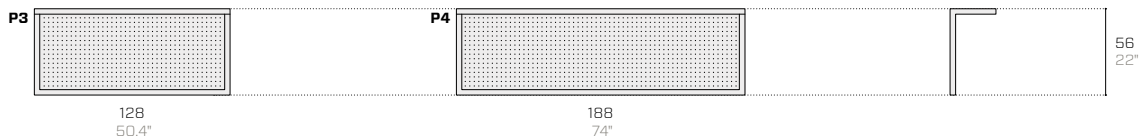

Compatible with 3000K LED bar
Compatibile con barra LED 3000K
Kompatibel mit 3000K LED Bar

Product / Prodotto / Produkt				Packaging / Imballo / Verpackung			
No.	Code	Dimensions (w-d-h)	Weight	Dimensions (w-d-h)	Weight	Vol pkg	
Nr.	Codice	Dimensioni (l-p-h)	Peso	Dimensioni (l-p-h)	Peso	Vol. collo	
Nr.	Code	Abmessungen (b-t-h)	Gewicht	Abmessungen (b-t-h)	Gewicht	Vol. Kollo	
:	:	cm	kg	cm	kg	mc	

Drawer kits (surcharge on the door price) / Kit cassetti (sovrapprezzo costo anta) / Schubladen-Set (Zuschlag auf den Türpreis)

01	FRK21C1	60 55 60	13	63 58 63	14	-
02	FRK20C2	60 55 60	18	63 58 63	19	-
03	FRK22C2	60 55 60	15	63 58 63	16	-
04	FRK23C3	60 55 60	20	63 58 63	21	-

Aluminum cutlery dividers / Divisori portaposate in alluminio / Besteckteiler aus aluminium

-	FRK09DP	48 8 5	1	50 10 6	1	-
---	---------	--------	---	---------	---	---

Waste separation systems / Kit di contenitori per raccolta differenziata / Abfalltrennsystem

-	FRK61DIF	44 29 22	3	50 10 6	1	-
-	FRK60DIF	46 30 30	2	50 10 6	1	-

Additional shelf / Ripiano aggiuntivo / Zusätzlicher Einlegeboden

-	FRK10R1	57 46 2	3	50 10 6	3	-
---	---------	---------	---	---------	---	---

Solid sheet metal wall panelling with shelf / Boiserie a muro in lamiera piena con mensola / Wandverkleidungen aus Vollblech mit Regal

P1	FRM01	128 30 56	18	- - -	21	-
P2	FRM02	188 30 56	27	- - -	31	-

Perforated sheet metal wall panelling with shelf / Boiserie a muro in lamiera forata con mensola / Wandverkleidungen aus Lochblech mit Regal

P3	FRM05	128 30 56	17	- - -	20	-
P4	FRM06	188 30 56	26	- - -	30	-

LED bar 3000K (10W per meter) / Barra LED 3000K (10W per metro) / LED-Lichtleiste 3000K (10W pro Meter)

-	FRS128L3	121 3.5 3.5	-	- - -	-	-
-	FRS188L3	181 3.5 3.5	-	- - -	-	-

24V-30W Power supply kit / Kit con alimentatore 24V-30W / Netzteil 24V-30W

-	FRSK1LPS	- - -	-	- - -	-	-
---	----------	-------	---	-------	---	---

Kit of 5 hooks / Kit di 5 gancetti / Kit mit 5 Haken

-	FRK29	- - -	-	- - -	-	-
---	-------	-------	---	-------	---	---

Kit of 5 magnets / Kit di 5 calamite / Kit mit 5 Magneten

-	FRK28	- - -	-	- - -	-	-
---	-------	-------	---	-------	---	---

Appliances and accessories / Elettrodomestici e accessori / Haushaltsgeräte und Zubehör

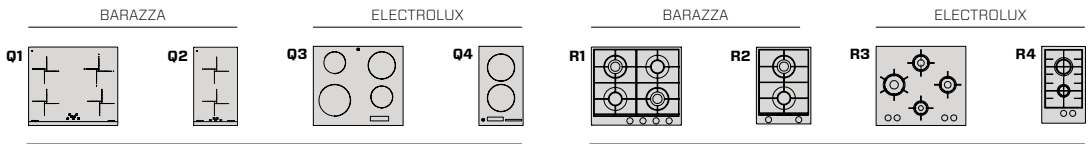

Electric induction hobs
Piani cottura elettrici a induzione
Elektrische Induktionskochfelder

Gas hobs
Piani cottura a gas
Gaskochfelder

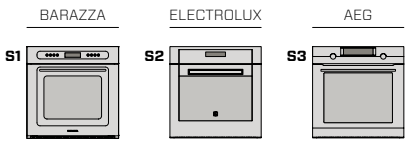

Ovens
Forni
Öfen

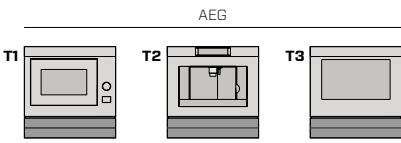

Microwave
Microonde
Microwelle

Coffee maker
Macchina del caffè
Kaffeemaschine

Wine cooler
Cantina
Weinkühlschrank

Integrated small drawer
Cassetto integrato
Integrierte Klein Schublade

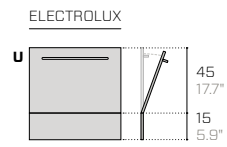

Dishwasher with Fantin door
Lavastoviglie con anta Fantin
Geschirrspüler mit Fantin Tür

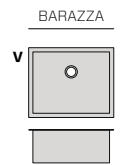

Under-top basin
Vasca satinata sottotop
Satin Unterbaubecken

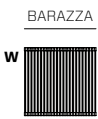

Roll-up draining mat
Griglia multiuso avvolgibile
Aufrollbare Abtropfmatte

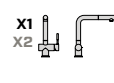

Steel taps
Rubinetti
Wasserhähne

X1: Chrome / Cromato / Chrom
X2: Black / Nero / Schwarz
X3: Barazza Inox Satin
X4: Barazza Inox Vintage

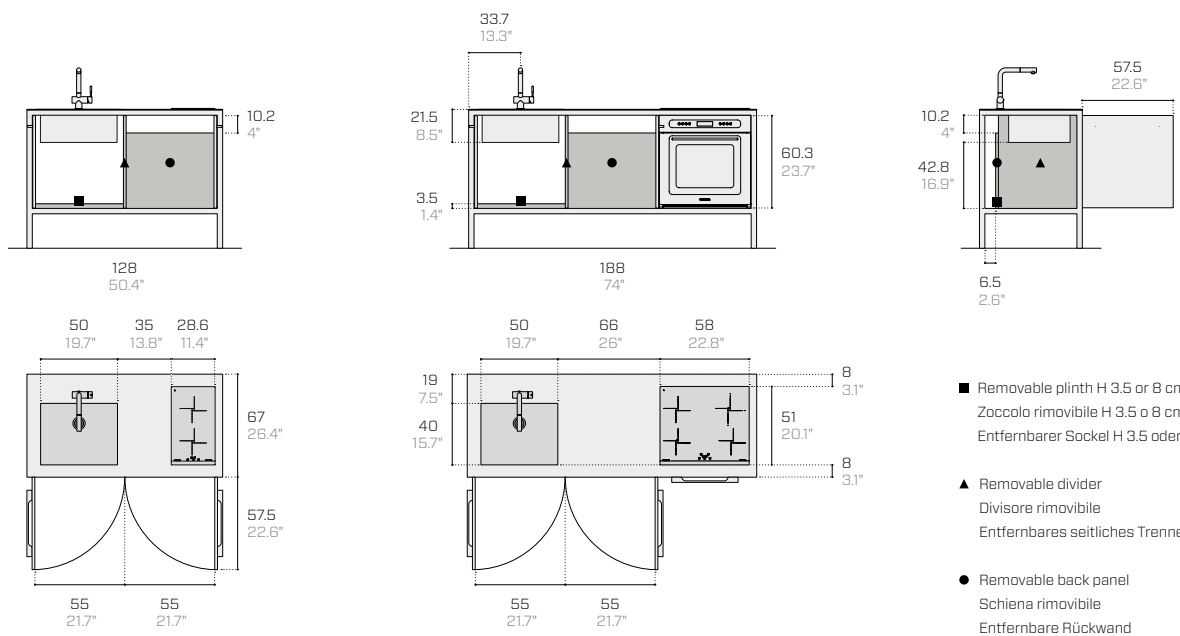

- Removable plinth H 3.5 or 8 cm
Zoccolo rimovibile H 3.5 o 8 cm
Entfernbarer Sockel H 3.5 oder 8 cm
- ▲ Removable divider
Divisoro rimovibile
Entfernbares seitliches Trennelement
- Removable back panel
Schiena rimovibile
Entfernbare Rückwand

Product / Prodotto / Produkt

Packaging / Imballo / Verpackung

No.	Code	Brand code	Dimensions (w-d-h)			Weight	Dimensions (w-d-h)			Weight
N.	Codice	Codice marca	Dimensioni (l-p-h)			Peso	Dimensioni (l-p-h)			Peso
Nr.	Code	Herstellercode	Abmessungen (b-t-h)			Gewicht	Abmessungen (b-t-h)			Gewicht
			cm			kg	cm			kg

Electric induction hobs / Piani cottura elettrici a induzione / Elektrische Induktionskochfelder

Q1	FRB05-F4	1PIDG64	58	51	5.2	12	87	60	13	14
Q2	FRB06-F2	1PID32NQ	29	51	5.4	6	39	60	13	10
Q3	FRE04	KT16430E	59	52	6.5	12	80	60	15	14
Q4	FRE02	EHH332ONOK	27	49	6.5	6	48	60	15	10

Gas hobs / Piani cottura a gas / Gaskochfelder

R1	FRE32	1PBF64	58	51	5.2	12	87	60	13	14
R2	FRE31	1PBF2	29	51	5.4	6	39	60	13	10
R3	FRE33	PQF645UOX	59	52	6.5	12	80	60	15	14
R4	FRE21	PQX32OV	27	49	6.5	6	48	60	15	10

Ovens (with installation kit) / Forni (con kit di installazione) / Backofen (mit Bausatz)

S1	FRB02V	1FUNPV	60	61	60	35	64	64	68	39
S2	FRE03	FQ203IXEV	60	60	55	33	64	64	68	37
S3	FRE05	BEK455220M	60	60	55	33	64	64	68	37

Appliances (with installation kit) / Elettrodomestici (con kit di installazione) / Haushaltselektrogeräte (mit Bausatz)

T1	FRE11	MBE2658DEM	60	53	60	28	66	54	53	31
T2	FRE12	KKK884500M	60	53	60	28	66	54	53	31
T3	FRE13	KWK884520M	60	53	60	28	66	54	53	31
U	FRE36	ESL2500RO	56	55	58	40	60	59	62	42

Accessories / Accessori / Zubehör

V	FRB08S	-	53	43	22	5	60	50	27	8
W	FRB11	-	47	45	1	1	50	8	8	1
X1	FRB10C	-	13	26	27	5	59	25	10	8
X2	FRB10N	-	13	26	27	5	59	25	10	8
X3	FRB10S	-	13	26	27	5	59	25	10	8
X4	FRB10V	-	13	26	27	5	59	25	10	8

S1



S2



S3



Bases / Basi / Basen

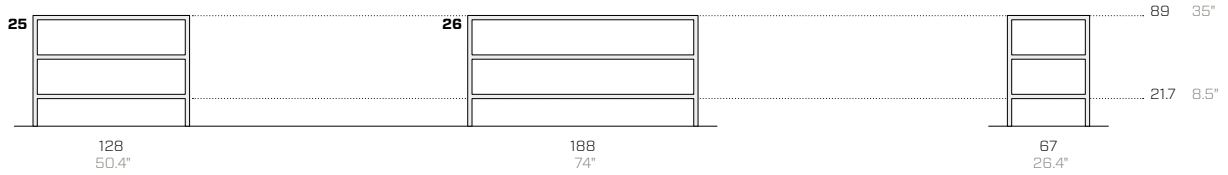

Top / Top / Arbeitsplatten



Accessories and details / Accessori e dettagli / Zubehör und Details

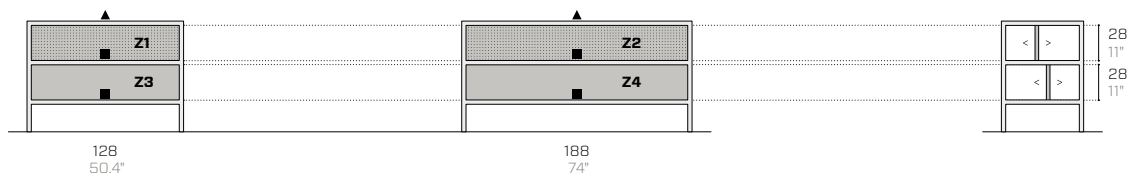

▲ Top (available in 4 versions)
 Top (disponibile in 4 versioni)
 Arbeitsplatte (in 4 Versionen erhältlich)

■ Lower shelves in metal (not replaceable)
 Ripiani inferiori in metallo (non sostituibili)
 Untere Regale aus Metall (nicht austauschbar)

Z. Full or perforated separator (freely positionable)
 Separatore pieno o forato (liberamente posizionabile)
 Voller oder perforierter Separator (frei positionierbar)

Top thickness / Spessore del top / Plattenstärke

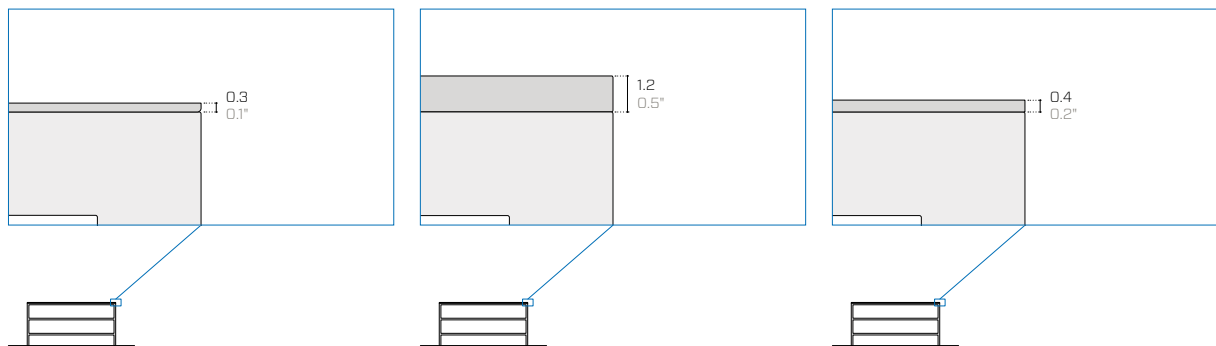

Metal top
 Top in metallo
 Arbeitsplatte aus Metall

Fenix top
 Top in Fenix
 Arbeitsplatte aus Fenix

Stainless steel top
 Top in acciaio
 Arbeitsplatte aus Edelstahl

Product / Prodotto / Produkt

Packaging / Imballo / Verpackung

No.	Code	Dimensions (w-d-h)	Weight	Dimensions (w-d-h)	Weight	Vol pkg
N.	Codice	Dimensioni (l-p-h)	Peso	Dimensioni (l-p-h)	Peso	Vol. collo
Nr.	Code	Abmessungen (b-t-h)	Gewicht	Abmessungen (b-t-h)	Gewicht	Vol. Kollo
		cm	kg	cm	kg	mc

Bases / Basi / Basen

25	FR88	128 67 89	60	150 80 107	103	1.30
26	FR81	188 67 89	75	200 80 107	118	1.80

Metal top / Top in metallo / Arbeitsplatte aus Metall

Y1	FR88TOPS	128 67 0.3	16	132 71 10	20	0.10
Y2	FR81TOPS	188 67 0.3	23	192 71 10	28	0.20

Food-grade tops are found at the Finishes section / Top a uso alimentare indicati nella sezione Finiture / Die Lebensmittel-geeignete Arbeitsplatten sind im Abschnitt Finishes aufgeführt

Fenix top / Top in Fenix / Mit Arbeitsplatte in Fenix

Y3	FRB21F	128 67 1.2	14	143 82 17	19	0.20
Y4	FRB51F	188 67 1.2	19	203 82 17	24	0.30

Satin finish stainless steel top (Barazza) / Top in acciaio Inox satinato (Barazza) / Arbeitsplatte aus Edelstahl mit Satin-Finish (Barazza)

Y5	FRB31F	128 67 0.4	28	137 80 21	50	0.30
Y6	FRB61S	188 67 0.4	40	197 80 21	50	0.40

Vintage finish stainless steel top (Barazza) / Top in acciaio Inox Vintage (Barazza) / Arbeitsplatte aus Edelstahl mit Vintage-Finish (Barazza)

Y7	FRB41V	128 67 0.4	28	137 80 21	50	0.30
Y8	FRB71V	188 67 0.4	40	197 80 21	50	0.40

Perforated separator / Separatore forato / Perforierter Separator

Z1	FRK05SF	128 28 4	4	132 32 5	9	0.10
Z2	FRK06SF	188 28 4	5	192 32 5	10	0.10

Full separator / Separatore pieno / Voller Separator

Z3	FRK07SC	128 28 4	5	132 32 5	9	0.10
Z4	FRK08SC	188 28 4	6	192 32 5	10	0.10

Wheel kit with colour-matching discs / Kit ruote con dischi in tinta / Radsatz mit farblich abgestimmten Scheiben

-	FRK31R8	8 3.5 10	2	20 10 10	3	0.10
---	---------	----------	---	----------	---	------

Metal essentials

	<p>01.18 Black (RAL 9005) Nero / Schwarz --- EM ▲ ■ MT</p>		<p>08.20 Rose quartz Rosa quarzo / Rosenquarz --- EM ▲</p>		<p>15.19 Forest green (RAL 6007) Verde bosco / Waldgrün --- EM ▲ ●</p>
	<p>02.18 Anthracite (RAL 7021) Antracite / Anthrazit --- EM ▲ ■ MT</p>		<p>09.18 Ruby red (RAL 3003) Rosso rubino / Rubinrot --- EM ▲</p>		<p>16.19 Turquoise blue (RAL 5018) Blu turchese / Türkisblau --- EM ▲</p>
	<p>03.18 Fantin grey Grigio Fantin / Fantin-Grau --- EM ▲ ■</p>		<p>10.21 Flame red (RAL 3000) Rosso fuoco / Feuerrot --- EM ▲ ●</p>		<p>17.18 Pastel blue (RAL 5024) Blu pastello / Pastellblau --- EM ▲ MT</p>
	<p>04.18 Light grey (RAL 7035) Grigio luce / Lichtgrau --- EM ▲ ■ MT</p>		<p>11.21 Melon yellow (RAL 1028) Giallo melone / Melonengelb --- EM ▲ ●</p>		<p>18.21 Dusty blue (RAL 5014) Azzurro polvere / Staubiges blau --- EM ▲ ●</p>
	<p>05.19 Cloud grey Grigio nuvola / Walkengrau --- EM ▲ ■</p>		<p>12.19 Zinc yellow (RAL 1018) Giallo zinco / Zinkgelb --- EM ▲</p>		<p>19.18 Gentian blue (RAL 5010) Blu genziana / Enzianblau --- EM ▲ ● MT</p>
	<p>06.18 White (RAL 9016) Bianco / Weiß --- EM ▲ ■ MT</p>		<p>13.21 Pastel green (RAL 6019) Verde pastello / Weißgrün --- EM ▲ ●</p>		<p>20.19 Steel blue (RAL 5011) Blu acciaio / Stahlblau --- EM ▲</p>
	<p>07.21 Milk white (RAL 9001) Bianco latte / Milchweiß --- EM ▲ ● ■ MT</p>		<p>14.18 Sage green (RAL 6021) Verde salvia / Salbeigrün --- EM ▲ ● MT</p>		<p>21.21 Coffee brown (RAL 8019) Marrone caffè / Kaffeebraun --- EM ▲</p>

Metal design

Metallic

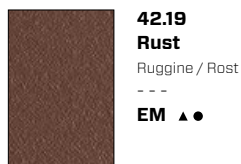
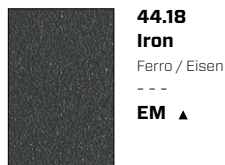
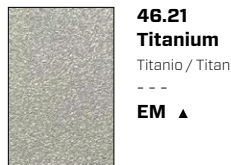
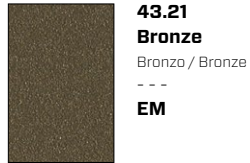

Earth

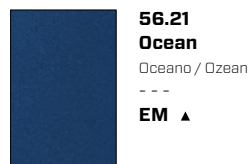
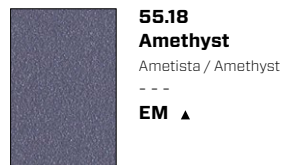
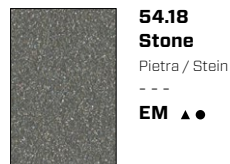
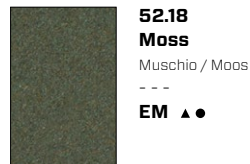

Surfaces / Superfici / Oberflächen

- EM** Embossed / Goffrato / Gaufriert
MT Matt / Opaco / Matt

Use / Utilizzo / Verwenden

- ▲ Tops / Top / Arbeitsplatte
● Outdoor / Esterni / Außenbereich
■ Food / Alimentare / Lebensmittel

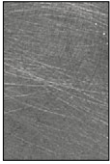
Inox Barazza**K1.18
Inox Vintage**

Inox Vintage / Inox Vintage

HG ▲●■**K2.19
Inox Satin**

Inox satinato / Inox satiniert

HG ▲●■

Surfaces / Superfici / Oberflächen**HG** High Gloss / Lucido / Glänzend

Use / Utilizzo / Verwenden

- ▲ Tops / Top / Arbeitsplatte
- Outdoor / Esterni / Außenbereich
- Food / Alimentare / Lebensmittel

Fenix NTM™

Best match available
Abbinamento suggerito
Paarungsvorschlag

F1.19
Nero Ingo

MT ▲ ■

01.18
Black (RAL 9005)
Nero / Schwarz

EM ▲ ■
MT

F2.19
Bianco Kos

MT ▲ ■

06.18
White (RAL 9016)
Bianco / Weiß

EM ▲ ■
MT

F3.19
Cacao Orinoco

MT ▲ ■

21.21
Coffee brown (RAL 8019)
Marrone caffè / Kaffeebraun

EM ▲

F4.19
Grigio Londra

MT ▲ ■

F5.19
Beige Arizona

MT ▲ ■

F6.19
Grigio Bromo

MT ▲ ■

F7.19
Blu Fes

MT ▲ ■

20.19
Steel blue (RAL 5011)
Blu acciaio / Stahlblau

EM ▲

The tops in Fenix NTM™ can be matched with all Fantin finishes. The correspondences in this page represent the best match available and are not intended as perfect colour equivalences.

I top in Fenix NTM™ sono abbinabili a tutte le finiture Fantin. Le corrispondenze di questa pagina sono indicative e non si intendono come perfette equivalenze di colore.

Die Platten in Fenix NTM™ können mit allen Fantin-Oberflächen abgestimmt werden. Die Entsprechungen auf dieser Seite stellen die beste verfügbare Übereinstimmung dar und sind nicht als perfekte Farbäquivalenzen gedacht.

Surfaces / Superfici / Oberflächen

- EM Embossed / Goffrato / Gaufriert
- MT Matt / Opaco / Matt

Use / Utilizzo / Verwenden

- ▲ Tops / Top / Arbeitsplatte
- Food / Alimentare / Lebensmittel

Technical information

Metal Non-toxic powder coating for interior use, with no heavy metals. Cured in an oven at 190°C, following degreasing and phosphating. Guaranteed minimum thickness of 50 microns. Minimum resistance to salt spray of 200 hours (in accordance with the ASTM B117 standard). Some finishes are suitable for direct contact with food as required by Italian Law Decree D.M. 21/03/73 and subsequent updates. Requests for other RAL finishes can be considered.

AISI 304 stainless steel Kitchen top with a thickness of 4 mm (0.16") with Vintage (exclusive Barazza manual processing, making it quicker and easier to maintain) or satin finish.

Fenix Top and stove tops in 12 mm (0.47") Fenix NTM™ thermolaminate. Super matt, smudgeproof and restorable, gives the surface a warm aesthetic and is soft to the touch. Fenix NTM™ finishes are paired with the Fantin Ultra-matt (Metal Design) collection in the price list, in order to create monochrome products.

Informazioni tecniche

Metallo Verniciatura per interni a polveri atossiche prive di metalli pesanti, con passaggio in forno a 190 °C, previo trattamento di sgrassaggio e fosfatazione. Spessore minimo garantito 50 micron, resistenza minima in nebbia salina pari a 200 ore (norma ASTM B117). Alcune finiture sono idonee al contatto diretto con alimenti come previsto dal decreto italiano D.M. 21/03/73 e successivi aggiornamenti. Altre finiture RAL valutabili su richiesta.

Acciaio Inox AISI 304 Piano cucina spessore 4 mm (0.16") con finitura Vintage (lavorazione manuale esclusiva Barazza, la cui manutenzione è più semplice e agevole) o satinata.

Fenix Top e piani cucina in termolaminato Fenix NTM™ di spessore 12 mm (0.47"). Super opaco, antimpronta e ripristinabile, dona alla superficie un'estetica calda e morbida al tatto. Le finiture Fenix NTM™ a listino sono corrispondenti alla collezione Fantin Ultra-matt (Metal Design), al fine di creare prodotti monocromatici.

Technische Informationen

Metall Die Pulverbeschichtung der gift- und schwermetalldfreien Pulverlacke für Innenbereiche erfolgt im Lackierofen bei 190 °C nach vorheriger Entfettung und Phosphatierung. Die garantierte Mindeststärke der Lackschicht beträgt 50 Mikron bei einer Mindestprüfungsdauer von 200 Stunden im Salznebel (ASTM-Norm B117). Einige Oberflächen sind für den direkten Kontakt mit Lebensmitteln geeignet, wie in der Verordnung vorgesehen Italienisch D.M. 21/03/73 und folgende Aktualisierungen. Auf Anfrage können andere RAL-Finishes in Betracht gezogen werden.

Edelstahl CNS AISI 304 Küchenarbeitsplatte Stärke 4 mm (0.16") mit Vintage-Finish (exklusive Handverarbeitung Barazza, die leicht und bequem zu pflegen ist) oder satiniert.

Fenix Abdeckung und Küchenarbeitsplatten aus Thermolaminat Fenix NTM™ in der Stärke 12 mm (0.47"). Die superopake Oberfläche mit Anti-Fingerprint-Schutz ist wiederherstellbar, hat eine warme Optik und eine weiche Haptik. Die Finishes Fenix NTM™ der Liste entsprechen denen der Kollektion Fantin Ultra-matt (Metal Design), sodass unifarbene Produkte entstehen.

Kitchens and workbenches from the Frame range, with a visible support structure and inset doors and drawers that are distinguishing visual features of the minimal design scheme.

Frame made of 35 x 35 mm (1.38" x 1.38") square tubes. Concealed adjustable feet.

Top made of Fenix with a thickness of 12 mm (0.47") or AISI 304 stainless steel filler panel with a thickness of 4 mm (0.16") with satin or Vintage finish (with exclusive Barazza manual processing). Also available with integrated 500 x 400 x 219 mm (19.69" x 15.75" x 8.62") sink.

Top (only for workbenches) made of metal with a thickness of 3 mm (0.12") and a bottom fibreboard filler panel.

Doors inset in the frame, made of bent and filled sheet metal. Door thickness: 20 mm (0.79"). Metal handles with a coating in a colour to match the doors. Soft-close dampening hinges. 95° door opening.

Drawers with fronts inset in the frame, made of bent and filled sheet metal. Drawer front thickness: 20 mm (0.79"). Metal handles with a coating in a colour to match the drawer fronts. Drawers with Hettich runners and built-in stabilization and soft-close systems. Capacity: 40 kg (88.18 lb).

Sides and bases inset in the frame, made of bent sheet metal; filled sides.

Inside shelves made of bent sheet metal.

Optional backboards inset in the frame, made of metal.

Optional wall boiserie with shelf.

Optional hobs – electric induction and gas – from Barazza, Electrolux.

Optional appliances with custom installation kit, from AEG, Barazza, Electrolux.

Optional accessories – under-top basin, roll-up draining mat, steel taps – from Barazza.

The kitchens are ready assembled (except for the tops).

Cucine e banconi del programma Frame, caratterizzato dal telaio portante in vista ed ante e cassetti in luce, che diventano caratteristiche estetiche dal design minimale.

Telaio in tubolare quadrato 35 x 35 mm (1.38" x 1.38"). Piedini invisibili regolabili.

Top in Fenix di spessore 12 mm (0.47") o in acciaio Inox AISI 304 di spessore 4 mm (0.16") con finitura satinata o Vintage (lavorazione manuale esclusiva Barazza). Disponibile anche con vasca integrata 500 x 400 x 219 mm (19.69" x 15.75" x 8.62").

Top in metallo (solo per banconi) in metallo di spessore 3 mm (0.12") con tamponamento inferiore in fibre di legno.

Ante in luce al telaio, in lamiera piegata e tamponata. Spessore delle ante 20 mm (0.79"). Maniglie in metallo verniciate in tinta con le ante. Cerniere ammortizzate. Apertura ante di 95°.

Cassetti con frontali in luce al telaio spessore 20 mm (0.79"), in lamiera piegata e tamponata. Maniglie in metallo verniciate in tinta con i frontali dei cassetti. Cassetti con guide Hettich, sistemi di stabilizzazione e soft-close integrati con portata 40 kg (88.18 lb).

Fianchi e fondi in luce al telaio, in lamiera piegata; fianchi tamponati.

Ripiani interni in lamiera piegata.

Schiene opzionali in metallo in luce al telaio.

Boiserie a parete opzionale con mensola.

Piani cottura opzionali – a induzione e a gas – Barazza, Electrolux.

Elettrodomestici opzionali – con kit di installazione personalizzato – AEG, Barazza, Electrolux.

Accessori opzionali – vasca satinata sottotop, griglia multiuso avvolgibile, rubinetti – Barazza.

Le cucine vengono fornite montate (top esclusi).

Küchen und Werkbänke aus der Frame-Linie mit sichtbarem Tragegestell und bündigen Türen und Schubläden, die zu den ästhetischen Eigenschaften eines Minimaldesigns werden.

Gestell aus Vierkantrohr 35 x 35 mm (1.38" x 1.38"). Unsichtbare, einstellbare Füße.

Arbeitsplatte in Fenix, Stärke 12 mm (0.47") oder massiver Edelstahl CNS AISI 304 in Stärke 4 mm (0.16") mit Satin- oder Vintage-Finish (exklusive Handverarbeitung Barazza). Ebenfalls verfügbar mit integriertem Waschbecken 500 x 400 x 219 mm (19.69" x 15.75" x 8.62").

Arbeitsplatte (nur für Werkbänke) aus 3 mm (0.12") starkem Metall mit unterer Holzfaserdämmung.

Türen aus gedämmtem Falzblech, bündig mit dem Gestell. Stärke der Türen 20 mm (0.79"). Pulverbeschichtete Metallgriffe gleichfarbig mit den Türen. Gedämpfte Scharniere. 95° Türöffnung.

Schubläden aus gedämmtem Falzblech, mit Fronten bündig mit dem Gestell. Schubladenfrontstärke: 20 mm (0.79"). Pulverbeschichtete Metallgriffe gleichfarbig mit den Schubladenfronten. Schubladen mit Führungsschienen Hettich mit Stabilisations- und Soft-Close-Systemen und mit einer Tragfähigkeit von 40 kg (88.18 lb).

Seiten und Basen aus Falzblech, bündig mit dem Gestell; bündig Seiten.

Innere Einlegeböden aus Falzblech.

Optionale Rückwände aus Metall, bündig mit dem Gestell.

Optionale Wandboiserie mit Regal.

Optionale Kochfelder – elektrische Induktion und Gas – von Barazza, Electrolux.

Optionales Haushaltsgeräte mit benutzerdefiniertes Bausatz, von AEG, Barazza, Electrolux.

Optionales Zubehör – satin Unterbaubecken, aufrollbare Abtropfmatte, Wasserhähne – von Barazza.

Die Küchen werden montiert geliefert (ohne Arbeitsplatten).

Disclaimer / Esclusione di responsabilità / Haftungsausschluss

Fantin Srl reserves the right to change the dimensions and features of the products contained in this technical data sheet at any time and without prior notice. The finishes illustrated are purely indicative as the accuracy tolerances of printing processes should be taken into account.

Fantin Srl si riserva la facoltà di modificare in qualsiasi momento e senza preavviso le dimensioni e l'esecuzione dei prodotti contenuti nella presente scheda tecnica. Le finiture riportate hanno valore indicativo in quanto soggette alle tolleranze dei processi di stampa.

Fantin Srl behält sich das Recht vor, die angegebenen Maße und Ausführungen der Produkte, welche dieses Produktblatt enthält, jederzeit ohne Vorankündigung zu ändern. Aufgrund drucktechnischer Abweichungen dienen die dargestellten Ausführungen nur der Illustration.

Fantin Srl

via San Vito, 43
33080 - Bannia
di Fiume Veneto (PN)
Italia

t +39 0434 959 133
f +39 0434 560 037
fantin@fantin.com
www.fantin.com



UNI EN ISO 9001