

# Uno Living

Dorino e Sandro Fantin, 2017

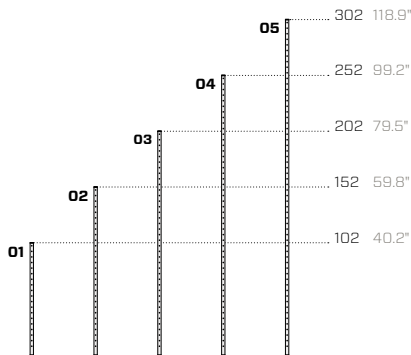

**Uprights / Montanti / Pfosten**



Slot pitch / Passo fori / Bohrungsabstand = 5 cm / 1.9"

**Standard shelves / Ripiani standard / Standard-Regalböden**

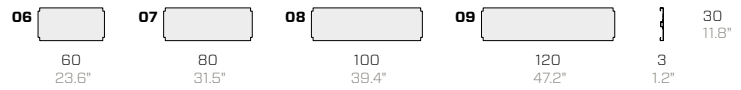

**Overhanging shelves / Ripiani a sbalzo / Auskragende Regalböden**

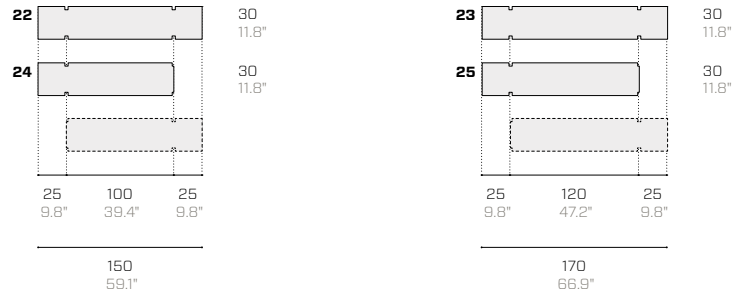

**Examples of compositions / Esempi di composizioni / Kompositionsbeispiele**

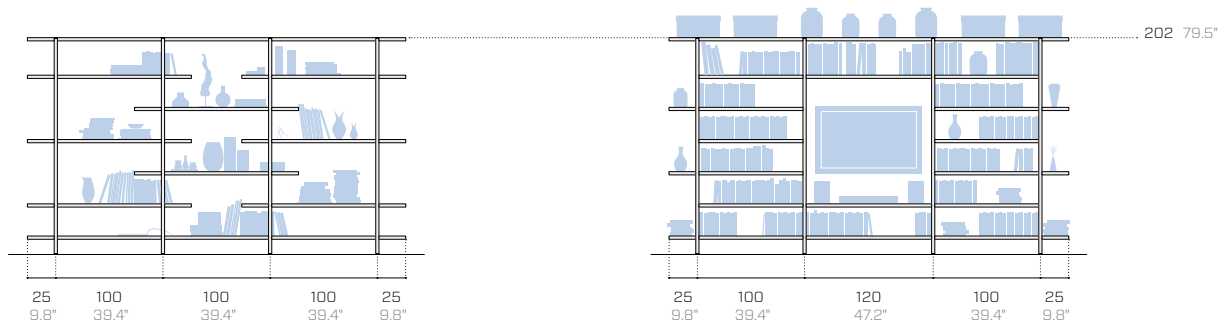
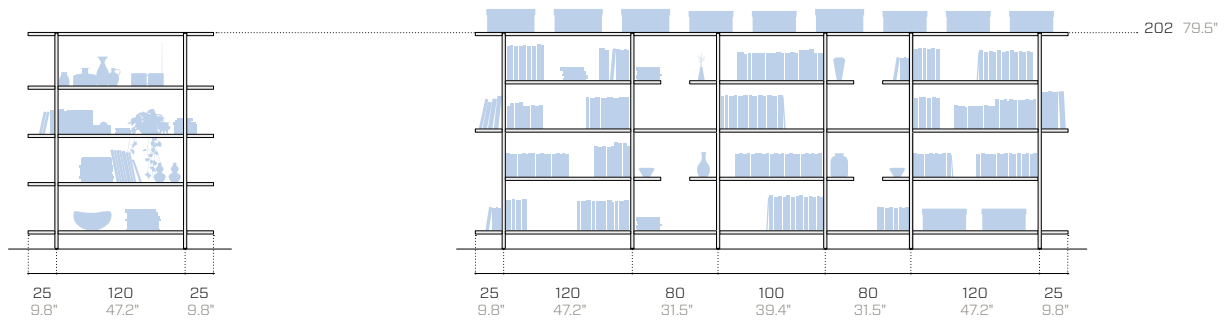

## Product / Prodotto / Produkt

## Packaging / Imballo / Verpackung

No.	Code	Dimensions (w-d-h)	Weight	Max capacity	Dimensions (w-d-h)	Weight	Vol pkg
N.	Codice	Dimensioni (l-p-h)	Peso	Capacità max	Dimensioni (l-p-h)	Peso	Vol. collo
Nr.	Code	Abmessungen (b-t-h)	Gewicht	Max. Tragfähigkeit	Abmessungen (b-t-h)	Gewicht	Vol. Kollo
		cm	kg	kg	cm	kg	mc

## Uprights / Montanti / Pfosten

01	FG100MON	3	3	102	1.1	-	-	1.2	0.01
02	FG150MON	3	3	152	1.7	-	-	1.8	0.01
03	FG200MON	3	3	202	2.3	-	-	2.4	0.01
04	FG250MON	3	3	252	2.9	-	-	3.0	0.01
05	FG300MON	3	3	302	3.5	-	-	3.6	0.01

## Standard shelves / Ripiani standard / Standard-Regalböden

06	FG603RIP	60	30	3	3.5	120	61	31	13	15.6	0.02
07	FG803RIP	80	30	3	2.8	200	81	31	13	12.8	0.03
08	FG103RIP	100	30	3	3.3	150	101	31	13	14.8	0.04
09	FG123RIP	120	30	3	4.0	120	121	31	13	17.6	0.05

## Overhanging shelves / Ripiani a sbalzo / Auskragende Regalböden

22	FG1503RIP	150	30	3	2.3	120	151	31	13	10.8	0.06
23	FG1703RIP	170	30	3	4.9	120	171	31	13	21.2	0.07
24	FG1253RIP	125	30	3	6.4	120	126	31	13	27.2	0.05
25	FG1453RIP	145	30	3	7.6	120	146	31	13	32.0	0.06

## Fastener / Gancio / Haken

-	FG001GAN	4.5	3.2	9.7	0.12	-	-	-	-	-	-
---	----------	-----	-----	-----	------	---	---	---	---	---	---

## Wall brackets / Staffe a parete / Wandbügel

-	FG171STA	6	3	4	0.1	-	-	-	-	-	-
---	----------	---	---	---	-----	---	---	---	---	---	---

Any composition requires stability and anti-tilting systems.

Qualsiasi composizione necessita di sistemi di stabilità e antiribaltamento.

Jede Zusammensetzung erfordert Stabilitäts- und Kippschutzsysteme.

The packaging details for the uprights will depend on the composition. The packaging details for the shelves are per pack of 4 items.

I dati di imballo per i montanti sono stabiliti in base alla composizione. I dati di imballo per i ripiani sono intesi per colli da 4 pezzi ciascuno.

Die Verpackungsdaten der Pfosten werden entsprechend der Komposition festgelegt. Die Verpackungsdaten der Regalböden verstehen sich für Verpackungseinheiten zu jeweils 4 Stück.



Stability and anti-tip systems / Sistemi di stabilità e antiribaltamento / Stabilisierung- und Kippschutzsysteme

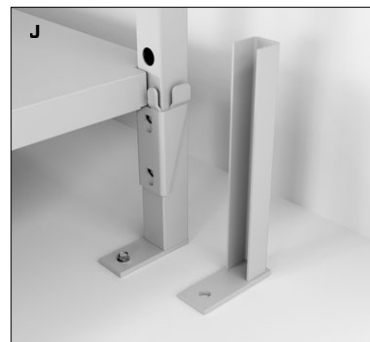
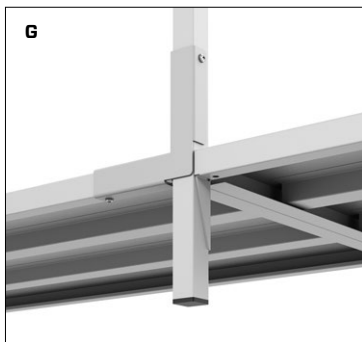
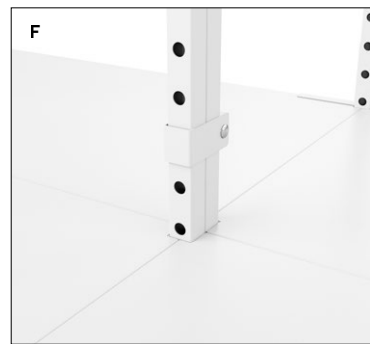
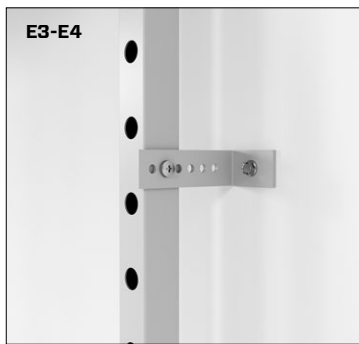
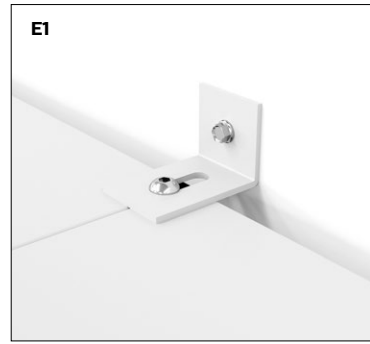
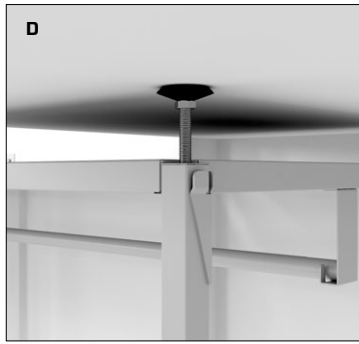
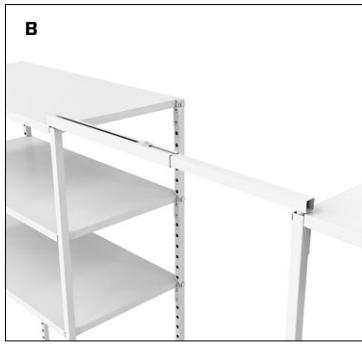
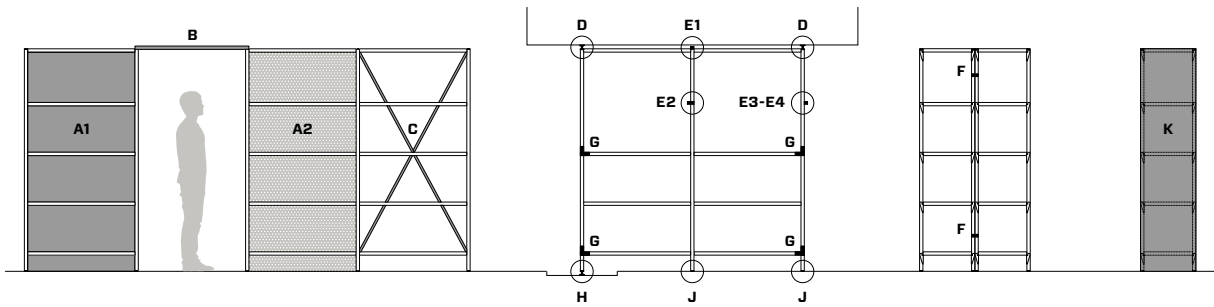

Product / Prodotto / Produkt					Packaging / Imballo / Verpackung			
No.	Code	Dimensions (w-d-h)	Weight	Max capacity	Dimensions (w-d-h)	Weight	Vol pkg	
Nr.	Codice	Dimensioni (l-p-h)	Peso	Capacità max	Dimensioni (l-p-h)	Peso	Vol. collo	
Nr.	Code	Abmessungen (b-t-h)	Gewicht	Max. Tragfähigkeit	Abmessungen (b-t-h)	Gewicht	Vol. Kollo	
		cm	kg	kg	cm	kg	mc	
Full-height blind back kit (euro/m2) / Kit schienale cieco a tutta altezza (euro/mq) / Set in voller Höhe geschlossene Rückwand (euro/qm)								
<b>A1</b>	FG014SCH	- - -	-	-	- - -	-	-	
Full-height perforated back kit (euro/m2) / Kit schienale forato a tutta altezza (euro/mq) / Set in voller Höhe gelochte Rückwand (euro/qm)								
<b>A2</b>	FG014SCH-F20	- - -	-	-	- - -	-	-	
Telescopic corridor bridge / Ponte telescopico corridoio / Teleskop-Regalbrücke								
<b>B</b>	FG800PON	- 3 3	2.5	-	- - -	-	-	
Diagonals kit / Kit diagonali / Set Stützkreuze								
<b>C</b>	FGDIA-102	2 0.5 100	2.3	-	- - -	-	-	
<b>C</b>	FGDIA-152	2 0.5 150	2.7	-	- - -	-	-	
<b>C</b>	FGDIA-202	2 0.5 200	3.0	-	- - -	-	-	
<b>C</b>	FGDIA-252	2 0.5 250	3.5	-	- - -	-	-	
<b>C</b>	FGDIA-302	2 0.5 300	3.9	-	- - -	-	-	
Adjustable ceiling fastening / Fissaggio regolabile a soffitto / Verstellbare Deckenbefestigung								
<b>D</b>	A114023734	8 3.5 4	0.1	-	- - -	-	-	
Wall brackets / Staffe a parete / Wandbügel								
<b>E1</b>	FG172STA	6.0 4.0 4.0	0.1	-	- - -	-	-	
<b>E2</b>	FG171STA	6.0 3.0 4.0	0.1	-	- - -	-	-	
<b>E3</b>	FG003STA	2.5 0.3 8.6	0.1	-	- - -	-	-	
<b>E4</b>	FG002STA	2.5 0.3 20.0	0.2	-	- - -	-	-	
U-shaped junction brackets / Staffe a U di unione / U-Verbindungsbügel								
<b>F</b>	FG007STA	8 3.5 4	0.1	-	- - -	-	-	
L-shaped stability brackets / Staffe a L di stabilità / L-förmiger Stützbügel								
<b>G</b>	FG283L	15 2.5 15	0.3	-	- - -	-	-	
Floor mounting bracket with adjustable foot / Staffa con piedino regolabile a terra / Bügel für Befestigung am Boden mit Stellfuß								
<b>H</b>	FG005STA	3 3 10.5	0.2	-	- - -	-	-	
Floor mounting bracket / Staffa di fissaggio a terra / Bügel für Befestigung am Boden								
<b>J</b>	A004PI	5 8 20.5	0.4	-	- - -	-	-	
Full-height blind side kit (euro/m2) / Kit fianco cieco a tutta altezza (euro/mq) / Set in voller Höhe geschlossene Seitenwand (euro/qm)								
<b>K</b>	FG016FIA	- - -	-	-	- - -	-	-	

Any composition requires stability and anti-tilting systems.

Qualsiasi composizione necessita di sistemi di stabilità e antiribaltamento.

Jede Zusammensetzung erfordert Stabilitäts- und Kippschutzsysteme.

## Metal essentials

	<p><b>01.18</b>  <b>Black (RAL 9005)</b>            Nero / Schwarz            ---  <b>EM</b> ▲ ■</p>		<p><b>08.20</b>  <b>Rose quartz</b>            Rosa quarzo / Rosenquarz            ---  <b>EM</b> ▲</p>		<p><b>15.19</b>  <b>Forest green (RAL 6007)</b>            Verde bosco / Waldgrün            ---  <b>EM</b> ▲ ●</p>
	<p><b>02.18</b>  <b>Anthracite (RAL 7021)</b>            Antracite / Anthrazit            ---  <b>EM</b> ▲ ● ■</p>		<p><b>09.18</b>  <b>Ruby red (RAL 3003)</b>            Rosso rubino / Rubinrot            ---  <b>EM</b> ▲</p>		<p><b>16.19</b>  <b>Turquoise blue (RAL 5018)</b>            Blu turchese / Türkisblau            ---  <b>EM</b> ▲</p>
	<p><b>03.18</b>  <b>Fantin grey</b>            Grigio Fantin / Fantin-Grau            ---  <b>EM</b> ▲ ■</p>		<p><b>10.21</b>  <b>Flame red (RAL 3000)</b>            Rosso fuoco / Feuerrot            ---  <b>EM</b> ▲ ●</p>		<p><b>17.18</b>  <b>Pastel blue (RAL 5024)</b>            Blu pastello / Pastellblau            ---  <b>EM</b> ▲</p>
	<p><b>04.18</b>  <b>Light grey (RAL 7035)</b>            Grigio luce / Lichtgrau            ---  <b>EM</b> ▲ ■</p>		<p><b>11.21</b>  <b>Melon yellow (RAL 1028)</b>            Giallo melone / Melonengelb            ---  <b>EM</b> ▲ ●</p>		<p><b>18.21</b>  <b>Dusty blue (RAL 5014)</b>            Azzurro polvere / Staubiges blau            ---  <b>EM</b> ▲ ●</p>
	<p><b>05.19</b>  <b>Cloud grey</b>            Grigio nuvola / Wolkengrau            ---  <b>EM</b> ▲ ■</p>		<p><b>12.19</b>  <b>Zinc yellow (RAL 1018)</b>            Giallo zinco / Zinkgelb            ---  <b>EM</b> ▲</p>		<p><b>19.18</b>  <b>Gentian blue (RAL 5010)</b>            Blu genziana / Enzianblau            ---  <b>EM</b> ▲ ●</p>
	<p><b>06.18</b>  <b>White (RAL 9016)</b>            Bianco / Weiß            ---  <b>EM</b> ▲ ■</p>		<p><b>13.21</b>  <b>Pastel green (RAL 6019)</b>            Verde pastello / Weißgrün            ---  <b>EM</b> ▲ ●</p>		<p><b>20.19</b>  <b>Steel blue (RAL 5011)</b>            Blu acciaio / Stahlblau            ---  <b>EM</b> ▲</p>
	<p><b>07.21</b>  <b>Milk white (RAL 9001)</b>            Bianco latte / Milchweiß            ---  <b>EM</b> ▲ ● ■</p>		<p><b>14.18</b>  <b>Sage green (RAL 6021)</b>            Verde salvia / Salbeigrün            ---  <b>EM</b> ▲ ●</p>		<p><b>21.21</b>  <b>Coffee brown (RAL 8019)</b>            Marrone caffè / Kaffeebraun            ---  <b>EM</b> ▲</p>

Metal design

Metallic



**41.18**  
**Gold**  
Oro / Gold  
---  
EM ▲



**43.21**  
**Bronze**  
Bronzo / Bronze  
---  
EM ▲



**47.21**  
**Platinum**  
Platino / Platin  
---  
EM ▲



**46.21**  
**Titanium**  
Titanio / Titan  
---  
EM ▲



**45.21**  
**Silver**  
Argento / Silber  
---  
EM ▲

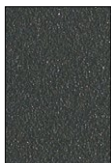

**44.18**  
**Iron**  
Ferro / Eisen  
---  
EM ▲



**42.19**  
**Rust**  
Ruggine / Rost  
---  
EM ▲●

Earth



**51.18**  
**Sand**  
Sabbia / Sand  
---  
EM ▲●

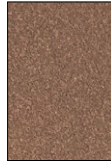

**57.21**  
**Clay**  
Creta / Lehm  
---  
EM ▲●



**52.18**  
**Moss**  
Muschio / Moos  
---  
EM ▲●



**53.18**  
**Basalt**  
Basalto / Basalt  
---  
EM ▲●



**54.18**  
**Stone**  
Pietra / Stein  
---  
EM ▲●



**55.18**  
**Amethyst**  
Ametista / Amethyst  
---  
EM ▲



**56.21**  
**Ocean**  
Oceano / Ozean  
---  
EM ▲

**Surfaces / Superfici / Oberflächen**

EM Embossed / Goffrato / Gaufriert

**Use / Utilizzo / Verwenden**

- ▲ Tops / Top / Arbeitsplatte
- Outdoor / Esterni / Außenbereich
- Food / Alimentare / Lebensmittel

---

**Technical information**

**Metal** Non-toxic powder coating for interior use, with no heavy metals. Cured in an oven at 190°C, following degreasing and phosphating. Guaranteed minimum thickness of 50 microns. Minimum resistance to salt spray of 200 hours (in accordance with the ASTM B117 standard). Some finishes are suitable for direct contact with food as required by Italian Law Decree D.M. 21/03/73 and subsequent updates. Requests for other RAL finishes can be considered.

**Informazioni tecniche**

**Metallo** Verniciatura per interni a polveri atossiche prive di metalli pesanti, con passaggio in forno a 190 °C, previo trattamento di sgrassaggio e fosfatazione. Spessore minimo garantito 50 micron, resistenza minima in nebbia salina pari a 200 ore (norma ASTM B117). Alcune finiture sono idonee al contatto diretto con alimenti come previsto dal decreto italiano D.M. 21/03/73 e successivi aggiornamenti. Altre finiture RAL valutabili su richiesta.

**Technische Informationen**

**Metall** Die Pulverbeschichtung der gift- und schwermetallfreien Pulverlacke für Innenbereiche erfolgt im Lackierofen bei 190 °C nach vorheriger Entfettung und Phosphatierung. Die garantierte Mindeststärke der Lackschicht beträgt 50 Mikron bei einer Mindestprüfungsdauer von 200 Stunden im Salznebel (ASTM-Norm B117). Einige Oberflächen sind für den direkten Kontakt mit Lebensmitteln geeignet, wie in der Verordnung vorgesehen Italienisch D.M. 21/03/73 und folgende Aktualisierungen. Auf Anfrage können andere RAL-Finishes in Betracht gezogen werden.



**Fantin's long-standing fastener-based shelving system is enriched by the addition of overhanging shelves, allowing all settings to be furnished with boundless versatility.**

**Uprights** in 30 x 30 mm (1.18" x 1.18") tubular metal measuring 1.2 mm (0.05") in thickness, fitted with plastic caps at the ends. Along the entire length, one side features slots with a pitch of 50 mm (1.97") for the variable positioning of the click fasteners and hence of the shelves. The use of tubular metal, which provides higher performance levels than the more commonly used open section bars, ensures minimal torsional and flexural effects.

**Click fasteners** made of pressed sheet metal, 2.5 mm (0.10") thick. These fasteners are anchored to the uprights using two purpose-designed side fins which fit into the slots in the uprights. The shelves then click onto the upper fins of the actual click-fasteners. Every click fastener is designed to support 2 consecutive shelves simultaneously, enveloping and concurrently reinforcing the upright to which it is anchored.

**Standard shelves** with a single depth of 30 cm, in 0.7 mm (0.03") thick sheet metal folded three times along the two front sides to prevent accidents; omega-shaped reinforcements are envisaged on the underside to increase their load capacity (UNI 8601/1984 test: level 5 out of 5). The four corners of the shelves are further reinforced with a 3 mm (0.12") thick sheet metal support that is designed to house the upright completely; this ensures perfect continuity between two consecutive shelves, without any gaps.

**Overhanging shelves** (single or double overhanging) with a single depth of 30 cm, in 0.7 mm (0.03") thick sheet metal folded three times along the accessible sides to prevent accidents; omega-shaped reinforcements are envisaged on the underside to increase their load capacity (UNI 8601/1984 test: level 5 out of 5). The housings of the uprights are further reinforced with a 3 mm (0.12") thick sheet metal support. The extension of the overhangings is always 25 cm (9.8").

This product is delivered unassembled. An assembly video is available at: [www.fantin.com](http://www.fantin.com).

Any composition requires stability and anti-tilting systems.

**Lo storico sistema di ripiani a ganci Fantin si arricchisce con l'inserimento dei ripiani a sbalzo, che permettono di arredare ogni ambiente con una versatilità senza limiti.**

**Montanti** in tubo 30 x 30 mm (1.18" x 1.18") di spessore 1.2 mm (0.05"), dotati alle estremità di tappi in plastica. Su tutta la lunghezza, un lato presenta forature passo 50 mm (1.97") che consentono il posizionamento variabile dei ganci, quindi dei ripiani. L'utilizzo del tubo, più performante rispetto ai profilati aperti comunemente utilizzati, garantisce effetti torsionali e flessionali minimi.

**Ganci** realizzati in lamiera stampata di spessore 2.5 mm (0.10"). L'ancoraggio al montante è possibile tramite due opportune alette laterali che si inseriscono nei fori dei montanti. I ripiani vengono successivamente fissati ad incastro sulle alette superiori dei ganci stessi. Ogni singolo gancio può sostenere contemporaneamente 2 ripiani consecutivi, abbracciando e rinforzando allo stesso tempo il montante al quale è ancorato.

**Ripiani** standard con profondità unica di 30 cm, in lamiera di spessore 0.7 mm (0.03") con triplice piegatura sui due lati frontali con funzione antinfortunistica; inferiormente sono previsti rinforzi ad omega che ne aumentano notevolmente la capacità di carico (prova UNI 8601/1984: livello 5 su 5). I quattro angoli dei ripiani sono ulteriormente rinforzati da un supporto in lamiera di spessore 3 mm (0.12") che consente l'alloggiamento completo del montante, al fine di ottenere una perfetta continuità tra due ripiani consecutivi, senza alcuna fessura.

**Ripiani a sbalzo** (sbalzo singolo o sbalzo doppio) con profondità unica di 30 cm, in lamiera di spessore 0.7 mm (0.03") con triplice piegatura con funzione antinfortunistica sui lati accessibili; inferiormente sono previsti rinforzi ad omega che ne aumentano notevolmente la capacità di carico (prova UNI 8601/1984: livello 5 su 5). Gli alloggiamenti dei montanti sono ulteriormente rinforzati da un supporto in lamiera di spessore 3 mm (0.12"). Il prolungamento degli sbalzi è sempre di 25 cm (9.8").

Il prodotto viene fornito smontato. Un video del montaggio è disponibile su: [www.fantin.com](http://www.fantin.com).

Qualsiasi composizione necessita di sistemi di stabilità e antiribaltamento.

**Das altbewährte System der Regalböden mit Haken Fantin bereichert sich mit dem Einfügen der Kragarmregale, mit denen es möglich ist, jedes Ambiente mit einer Vielseitigkeit ohne Grenzen einzurichten.**

**Pfosten** aus Metallrohr 30 x 30 mm (1.18" x 1.18") mit einer Stärke von 1.2 mm (0.05"), mit Plastikpfropfen an den Ende. Auf der gesamten Länge befinden sich Bohrungen, die eine variable Positionierung der Haken und Regalböden mit einem Abstand von 50 mm (1.97") ermöglichen. Dank der Metallrohre, die statt der üblicherweise eingesetzten offenen Profileisen verwendet werden, werden Torsions- und Biegeeffekte auf ein Minimum reduziert.

**Gekrüpfte Haken** aus Stanzblech mit einer Stärke von 2.5 mm (0.10"). Die Verankerung am Pfosten erfolgt über zwei Flügel, die in die Bohrungen des Pfostens eingeführt werden. Die Regalböden werden dann auf die oberen Flügel der Haken aufgesteckt. An jeden der Haken können gleichzeitig 2 nebeneinanderliegende Regalböden befestigt werden. Zudem umfasst der Haken den Pfosten und verstärkt ihn auf diese Weise.

**Standard-Regalböden** mit einer einzigen Tiefe von 30 cm, aus Blech mit einer Stärke von 0.7 mm (0.03") mit dreifacher Sicherheitsfaltung auf beiden Vorderseiten; auf der Unterseite befinden sich Omega-Profile, die die Tragfähigkeit der Böden erhöhen (Prüfung nach UNI 8601/1984: Stufe 5 von 5). Die vier Ecken der Regalböden werden zusätzlich durch eine Halterung aus Blech mit einer Stärke von 3 mm (0.12") verstärkt, die den Pfosten vollständig aufnimmt, so dass zwischen zwei benachbarte Regalböden kein Spalt und somit eine durchgehende Ablagefläche entsteht.

**Auskragende Regalböden** (Einzel- oder Doppel auskragenden) mit einer einzigen Tiefe von 30 cm, aus Blech mit einer Stärke von 0.7 mm (0.03") mit dreifacher Sicherheitsfaltung auf den zugänglichen Seiten; auf der Unterseite befinden sich Omega-Profile, die die Tragfähigkeit der Böden erhöhen (Prüfung nach UNI 8601/1984: Stufe 5 von 5). Die Gehäuse der Pfosten werden zusätzlich durch eine Halterung aus Blech mit einer Stärke von 3 mm (0.12") verstärkt. Die Verlängerung der Auskragungen ist immer 25 cm (9.8").

Das Produkt wird unmontiert geliefert. Ein Montagevideo ist verfügbar unter: [www.fantin.com](http://www.fantin.com).

Jede Zusammensetzung erfordert Stabilitäts- und Kippschutzsysteme.

**Disclaimer / Esclusione di responsabilità / Haftungsausschluss**

Fantin Srl reserves the right to change the dimensions and features of the products contained in this technical data sheet at any time and without prior notice. The finishes illustrated are purely indicative as the accuracy tolerances of printing processes should be taken into account.

Fantin Srl si riserva la facoltà di modificare in qualsiasi momento e senza preavviso le dimensioni e l'esecuzione dei prodotti contenuti nella presente scheda tecnica. Le finiture riportate hanno valore indicativo in quanto soggette alle tolleranze dei processi di stampa.

Fantin Srl behält sich das Recht vor, die angegebenen Maße und Ausführungen der Produkte, welche dieses Produktblatt enthält, jederzeit ohne Vorankündigung zu ändern. Aufgrund drucktechnischer Abweichungen dienen die dargestellten Ausführungen nur der Illustration.

**Fantin Srl**

via San Vito, 43  
33080 - Bannia  
di Fiume Veneto (PN)  
Italia

t +39 0434 959 133  
f +39 0434 560 037  
fantin@fantin.com  
www.fantin.com



UNI EN ISO 9001