

# Frame

## Stools

Salvatore Indriolo, 2022



[> go to the outdoor version](#)

Low stool / Banqueta baja / Tabouret bas

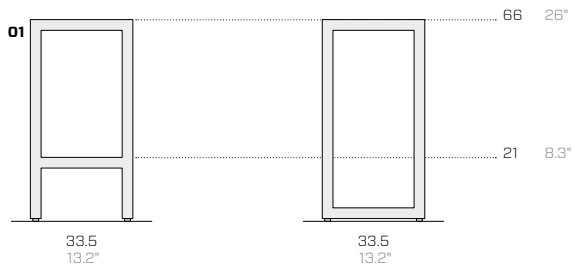

High stool / Banqueta alta / Tabouret haut

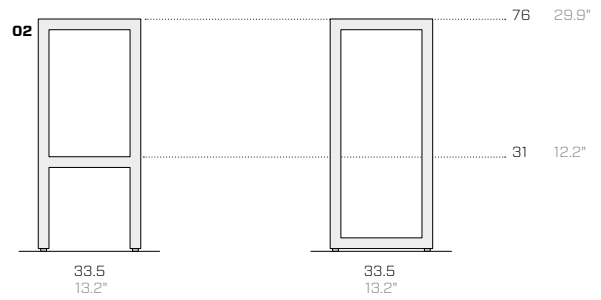

Combination with Frame Workbenches / Combinación con Frame Workbenches / Combinaison avec Frame Workbenches

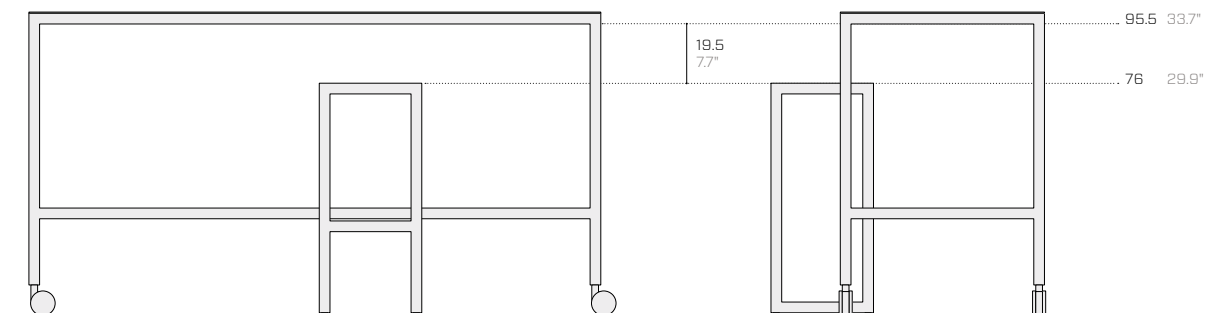
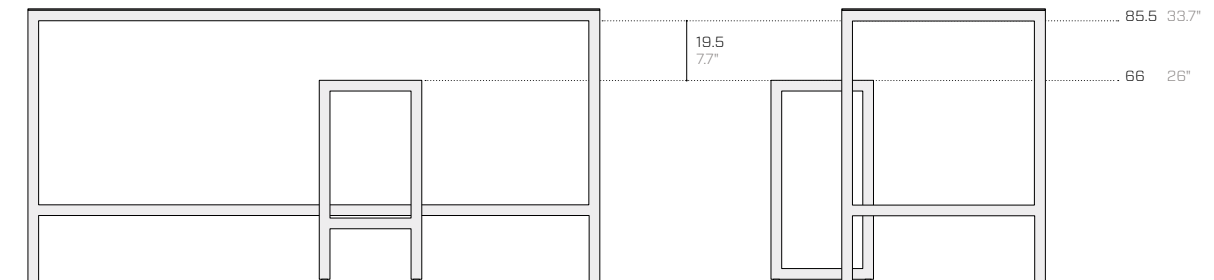

**Product / Producto / Produit**

**Packaging / Embalaje / Emballage**

No.	Code	Dimensions (w-d-h)	Weight	Dimensions (w-d-h)	Weight	Vol pkg
No.	Código	Dimensiones (l-a-a)	Peso	Dimensiones (l-a-a)	Peso	Vol. paq.
N°	Code	Dimensions (l-p-h)	Poids	Dimensions (l-p-h)	Poids	Vol. paq.
:	:	cm	kg	cm	kg	mc

**Low stool / Banqueta baja / Tabouret bas**

<b>01</b>	FRG01	33.5 33.5 66	7	37.5 37.5 80	9	0.2
-----------	-------	--------------	---	--------------	---	-----

**High stool / Banqueta alta / Tabouret haut**

<b>02</b>	FRG02	33.5 33.5 76	8	37.5 37.5 80	10	0.2
-----------	-------	--------------	---	--------------	----	-----

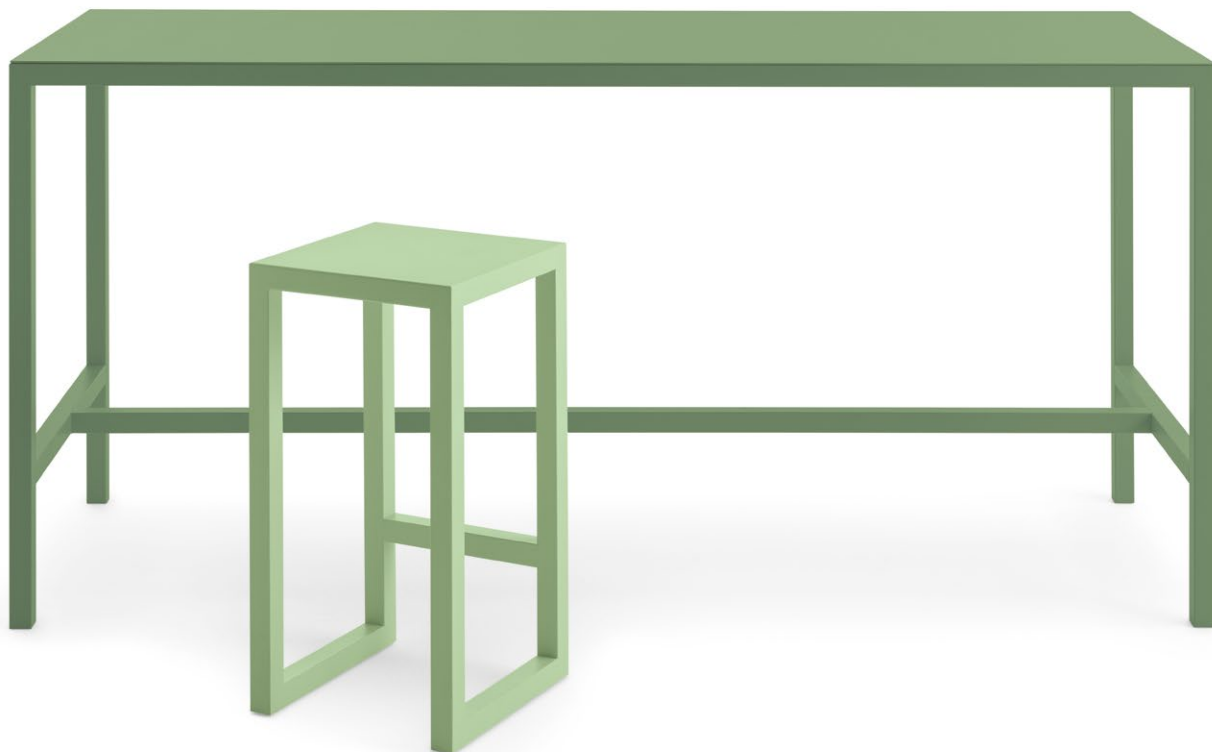

## Metal essentials

	<p><b>01.18</b>  <b>Black (RAL 9005)</b>            Negro / Noir            ---  <b>EM ▲</b></p>		<p><b>08.20</b>  <b>Rose quartz</b>            Rosa cuarzo / Quartz rose            ---  <b>EM ▲■</b></p>		<p><b>15.19</b>  <b>Forest green (RAL 6007)</b>            Verde bosque / Verte forêt            ---  <b>EM ▲●</b></p>
	<p><b>02.18</b>  <b>Anthracite (RAL 7021)</b>            Antracita / Anthracite            ---  <b>EM ▲●■</b></p>		<p><b>09.24</b>  <b>Terracotta (RAL 8004)</b>            Terracota / Terre cuite            ---  <b>EM ▲●■</b></p>		<p><b>16.24</b>  <b>Cement (RAL 7033)</b>            Cemento / Ciment            ---  <b>EM ▲●■</b></p>
	<p><b>03.18</b>  <b>Fantin grey</b>            Fantin gris / Gris Fantin            ---  <b>EM ▲●■</b></p>		<p><b>10.21</b>  <b>Flame red (RAL 3000)</b>            Rojo Fuego / Rouge feu            ---  <b>EM ▲</b></p>		<p><b>17.24</b>  <b>Slate (RAL 7031)</b>            Pizarra / Ardoise            ---  <b>EM ▲●■</b></p>
	<p><b>04.18</b>  <b>Light grey (RAL 7035)</b>            Gris claro / Gris clair            ---  <b>EM ▲●■</b></p>		<p><b>11.21</b>  <b>Melon yellow (RAL 1028)</b>            Amarillo melón / Jaune melon            ---  <b>EM ▲●</b></p>		<p><b>18.21</b>  <b>Dusty blue (RAL 5014)</b>            Azul polvoriento / Bleu poussiéreux            ---  <b>EM ▲■</b></p>
	<p><b>05.19</b>  <b>Cloud grey</b>            Gris nube / Gris nuage            ---  <b>EM ▲■</b></p>		<p><b>12.19</b>  <b>Zinc yellow (RAL 1018)</b>            Amarillo zinc / Jaune de zinc            ---  <b>EM ▲■</b></p>		<p><b>19.18</b>  <b>Gentian blue (RAL 5010)</b>            Azul genciana / Bleu gentiane            ---  <b>EM ▲●</b></p>
	<p><b>06.18</b>  <b>White (RAL 9016)</b>            Blanco / Blanc            ---  <b>EM ▲■</b></p>		<p><b>13.21</b>  <b>Pastel green (RAL 6019)</b>            Verde pastel / Vert pastel            ---  <b>EM ▲●■</b></p>		<p><b>20.19</b>  <b>Steel blue (RAL 5011)</b>            Azul acero / Bleu acier            ---  <b>EM ▲</b></p>
	<p><b>07.21</b>  <b>Milk white (RAL 9001)</b>            Blanco leche / Blanc de lait            ---  <b>EM ▲●■</b></p>		<p><b>14.18</b>  <b>Sage green (RAL 6021)</b>            Verde salvia / Vert sauge            ---  <b>EM ▲●■</b></p>		<p><b>21.21</b>  <b>Coffee brown (RAL 8019)</b>            Marrón café / Marron café            ---  <b>EM ▲■</b></p>

Metal design

Metallic



**61.24**  
**Pale gold**  
Oro claro / Or clair  
---  
EM ▲ ■



**62.24**  
**Copper**  
Cobre / Cuivre  
---  
EM ▲ ● ■



**47.21**  
**Platinum**  
Platino / Platine  
---  
EM ▲



**43.21**  
**Bronze**  
Bronce / Bronze  
---  
EM ▲



**63.24**  
**Graphite**  
Grafito / Graphite  
---  
EM ▲ ●

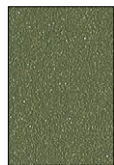

**64.24**  
**Silver green**  
Verde plateado / Vert argenté  
---  
EM ▲ ●



**65.24**  
**Silver blue**  
Azul plateado / Bleu argenté  
---  
EM ▲ ●

Earth



**51.18**  
**Sand**  
Arena / Sable  
---  
EM ▲ ●



**57.21**  
**Clay**  
Creta / Crète  
---  
EM ▲ ●



**52.18**  
**Moss**  
Musgo / Mousse  
---  
EM ▲ ●



**66.24**  
**Lichen**  
Liquen / Lichen  
---  
EM ▲ ■



**67.24**  
**Pink clay**  
Arcilla rosa / Argile rose  
---  
EM ▲ ● ■

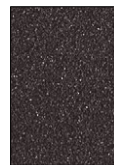

**68.24**  
**Sodalite**  
Sodalita / Sodalite  
---  
EM ▲



**56.21**  
**Ocean**  
Oceano / Océan  
---  
EM ▲

**Surfaces / Superficies / Surfaces**

EM Embossed / Gofrado / Gaufré

**Use / Usos / Utilisations**

- ▲ Tops / Encimeras / Plans
- Outdoor / Exteriores / Extérieur
- Food / Alimentario / Alimentaire

---

**Technical information**

**Metal** Non-toxic powder coating for interior use, with no heavy metals. Cured in an oven at 190 °C, following degreasing and phosphating. Guaranteed minimum thickness of 50 microns. Minimum resistance to salt spray of 200 hours (in accordance with the ASTM B117 standard). Some finishes are suitable for direct contact with food as required by Italian Law Decree D.M. 21/03/73 and subsequent updates. Requests for other RAL finishes can be considered. On some finishes, any partial discolouration following rubbing and/or abrasion has absolutely no effect on the technical, appearance/colour and chemical/physical characteristics of the product. This phenomenon tends to diminish over the useful life of the product and does not in any case present a health hazard to users.

---

**Información técnica**

**Metal** Recubrimiento en polvo atóxico para interiores, sin metales pesados, con paso en horno a 190 °C, previo tratamiento de desengrase y fosfatación. Espesor mínimo garantizado 50 micrones, resistencia mínima en niebla salina igual a 200 horas (norma ASTM B117). Algunos acabados son aptos para el contacto directo con alimentos, según lo previsto por el decreto italiano D.M. 21/03/73 y posteriores actualizaciones. Se pueden evaluar otros acabados RAL bajo pedido. En algunos acabados, una decoloración parcial debida al roce y/o a la abrasión no afecta en absoluto a las características técnicas, de aspecto/color y químicas/físicas del producto. Este fenómeno tiende a disminuir a lo largo de la vida útil del producto y no representa en ningún caso un peligro para la salud de los usuarios.

---

**Informations techniques**

**Métal** Revêtement en poudre non toxique pour l'intérieur sans métaux lourds, avec passage au four à 190 °C, après traitement de dégraissage et de phosphatation. Épaisseur minimale garantie de 50 microns. Résistance minimale au brouillard salin de 200 heures (norme ASTM B117). Certaines finitions sont adaptées au contact direct avec les aliments, comme l'exige l'arrêté ministériel italien du 21/03/73 et ses mises à jour ultérieures. Autres finitions RAL possibles sur demande. Sur certaines finitions, une éventuelle décoloration partielle due au frottement et/ou à l'abrasion n'a absolument aucune incidence sur les caractéristiques techniques, d'aspect/couleur et chimiques/physiques du produit. Ce phénomène tend à s'atténuer au cours de la vie utile du produit et ne présente en aucun cas un danger pour la santé des utilisateurs.

**This sturdy stool has an iconic structure and carefully considered proportions. It can be customized with all of the colours in the Fantin palette, so it is ideal for every setting.**

**Single-piece frame** made of 35 x 35 mm (1.38" x 1.38") square tubes, all of which are fully welded. Rubber feet.

**Seat** made of 1.5 mm (0.06") thick sheet metal that is bent and welded to the frame.

*This product is ready assembled.*

*This product is also available for outdoor use.*

**Una banqueta sólida con una estructura icónica y proporciones bien cuidadas, apta para cualquier contexto gracias a la posibilidad de personalización con toda la paleta de colores Fantin.**

**Marco de una sola pieza** en tubo cuadrado 35 x 35 mm (1.38" x 1.38") con todas sus partes soldadas. Patas de goma.

**Asiento** en chapa de 1.5 mm (0.06") de espesor plegada y soldada al marco.

*El producto se suministra montado.*

*El producto también está disponible para uso en exteriores.*

**Un tabouret solide, à la structure iconique et aux proportions harmonieuses, qui s'adapte à tous les contextes grâce à la possibilité de le personnaliser avec toute la palette de couleurs Fantin.**

**Cadre monobloc** en tube carré de 35 x 35 mm (1.38" x 1.38") entièrement soudé. Pieds en caoutchouc.

**Assise** en tôle de 1.5 mm (0.06") d'épaisseur pliée et soudée au cadre.

*Le produit est livré monté.*

*Le produit est également disponible pour une utilisation en extérieur.*

#### Disclaimer / Descargo de responsabilidad / Exclusion de responsabilité

Fantin Srl reserves the right to change the dimensions and features of the products contained in this technical data sheet at any time and without prior notice. The finishes illustrated are purely indicative as the accuracy tolerances of printing processes should be taken into account.

Fantin Srl se reserva el derecho de modificar en cualquier momento y sin previo aviso las dimensiones y ejecución de los productos presentes en esta ficha técnica. Los acabados mostrados son indicativos, ya que están sujetos a las tolerancias de los procesos de impresión.

Fantin Srl se réserve le droit de modifier à n'importe quel moment et sans préavis les dimensions et la fabrication des produits contenus dans cette fiche technique. Les finitions indiquées sont données à titre indicatif puisqu'elles sont sujettes aux tolérances des procédés d'impression.

#### Fantin Srl

via San Vito, 43  
33080 - Bannia  
di Fiume Veneto (PN)  
Italia

t +39 0434 959 133  
f +39 0434 560 037  
fantin@fantin.com  
www.fantin.com

